



HOTEL CATALOGUE

 **EYMIEN**
TOURISM HOTEL TEXTILE D.O.O.





HOTEL TEXTILE EQUIPMENT
SINCE 1990



MONTENEGRO / OFFICE



+382 68 395579

Bulevar Veljka Vlahovica, II zgrada Fis Jase Invest, Poslovni Broj 8
Stari Aerodrom, Podgorica

info@eymen.me / www.eymen.me

TURKEY / ISTANBUL CENTER OFFICE



SANTRAL HOTEL TEKSTİL EKİPMANLARI
İNŞAAT DEKORASYON LTD. ŞTİ.

Kazlıçeşme Mah. Abay Cad. No:227
Zeytinburnu / İstanbul

(+90) 532 405 98 11

(+90) 533 096 34 44

www.santraloteltekstil.com

info@santraloteltekstil.com





CONTENTS

OUR REFERENCES	04-07
HOTEL TEXTILE PRODUCTS	08-37
HOTEL CURTAINS AND PRODUCTS	38-43
BEDS & BASES	44-63
IN-ROOM EQUIPMENT	64-70
HOTEL RESTAURANT PRODUCTS	71-73
CARPET, PARQUET AND WALLPAPER	74-80
BATHROOM EQUIPMENT.....	81-86
HOTEL FLOORING AND CLEANING PRODUCTS·	87-89
HOTEL AMENITIES & SPA	90-96

OUR REFERENCES

- RAMADA HOTEL / PODGORICA
- IBEROSTAR HOTEL / BEČÍCI
- ADAMAR HOTEL
- ALBATROS HOTEL
- ALP INN HOTEL
- ALPİN HOTEL
- AMETHYST HOTEL
- AMIRAL PALACE HOTEL
- AMSTERDAM HOTEL
- ANTIS HOTEL
- ANTUSA DESIGN HOTEL
- ARDEN HOTEL
- ART NOUVEAU HOTEL
- ASIA CITY HOTEL
- ASPEN HOTEL
- AVCI PALACE HOTEL
- AVICANNE HOTEL
- BARKOD HOTEL
- BAVER HOTEL
- BEETHOVEN HOTEL
- BEKDAŞ HOTEL
- BENTLEY HOTEL
- BEYAZ SARAY HOTEL
- BIZANTIUM HOTEL
- BLACK BIRD HOTEL
- BLACK TULIP HOTEL
- BLUE RAYMOND HOTEL
- BRAKO HOTEL
- BRAM HOTEL
- BUDO HOTEL
- BUKE HOTEL
- BURÇKIN HOTEL
- BÜYÜK KULÜP
- BÜYÜK PARIS HOTEL
- BYZANTIUM HOTEL
- CASTEL FRANCO HOTEL & SUITE
- CELAL AĞA KONAĞI
- CITY CENTER HOTEL
- CORNER HOTEL
- ÇAĞYİĞİT HOTEL
- DALAN HOTEL
- DANIŞ HOTEL
- DARKHILL HOTEL
- DARKMEN HOTEL

OUR REFERENCES

- DARU SULTAN HOTEL
- DELTA HOTEL
- DOSSO DOSSİ HOTEL
- DURMAZ HOTEL
- DÜNDAR HOTEL
- EDİBE SULTAN HOTEL
- ELİTE WORLD HOTEL FLORYA
- ELİTE WORLD HOTEL HALKALI
- ELİTE WORLD HOTEL MARMARİS
- ELİTE WORLD HOTEL TAKSİM
- ELİTE WORLD HOTEL VAN
- EMİRHAN PLACE HOTEL
- EMOS HOTEL
- ENDİCAN HOTEL
- ESANS HOTEL
- ESCARDIN HOTEL
- EUROSTAR HOTEL
- FİDAN CITY HOTEL
- FLORA HOTEL
- FORS HOTEL
- FORSEVEN HOTEL
- GLORIOUS HOTEL
- GRAND ARAS HOTEL
- GRAND AŞIYAN HOTEL
- GRAND BEYAZIT HOTEL
- GRAND DURMAZ HOTEL
- GRAND GALATA HOTEL
- GRAND GÜLSOY HOTEL
- GRAND HALIÇ HOTEL
- GRAND HILARYUM HOTEL
- GRAND MADRID HOTEL
- GRAND MARCELLO HOTEL
- GRAND MIRA HOTEL
- GRAND ONS HOTEL
- GRAND SAĞCANLAR HOTEL
- GRAND ÜNAL HOTEL
- HALİFAKS HOTEL
- HAMIT BEY HOTEL
- HAVA KUVVETLERİ KOM.
- HILARIUM HOTEL
- HISTORY LOVELY HOTEL
- HİLTON TASHKENT
- ICON ISTANBUL HOTEL
- ISTANBUL MY DREAM HOTEL

OUR REFERENCES

- İLKBAL HOTEL
- İSTANBUL MIDPOINT HOTEL
- KİLİS OLEA HOTEL
- KUMRU HOTEL
- KYBELA HOTEL
- LADY DIANA HOTEL
- LE MARDEN HOTEL
- LEMİS HOTEL
- LIBERTY HOTEL
- LYON HOTEL
- MARBLE HOTEL
- MARCELLO HOTEL
- MARISTA HOTEL
- MARTINEZ HOTEL
- MATARACI KONAK
- MAYS ROYAL HOTEL
- MEVLANA OLD CITY
- MIDLE ASIA HOTEL
- MIDMAR HOTEL
- MIROLAYN HOTEL
- MISS HOTEL
- MOMENTO HOTEL
- MONACO HOTEL
- MOSAIC HOTEL
- MY HOUSE HOTEL
- NAUMPASA KONAĞI
- NENA HOTEL
- NEW STAR HOTEL
- NIPPON HOTEL
- NİDA HOTEL
- NO 12 HOTEL
- PASHA PLACE HOTEL
- PELL PALACE HOTEL
- PERA BOSPHOURUS HOTEL
- PERA ROSE HOTEL
- PERAHILL HOTEL
- PERALUNA HOTEL
- PİYA SPORT HOTEL
- POINT ANKARA HOTEL
- POINT BARBAROS HOTEL
- POINT HOTEL TAKSİM
- REAL STAR HOTEL
- REKOR HOTEL
- KENSINGTON HOTEL

OUR REFERENCES

- REPORT HOTEL
- ROSE GARDEN HOTEL
- RUMORS INN HOTEL
- SELENAY HOTEL
- SENATUS HOTEL
- SERES HOTEL
- SEVEN HILLS HOTEL
- SINEM HOTEL
- SKALION HOTEL
- SKY KAMER BUTIK HOTEL
- SKYSTAR HOTEL
- SORISSO HOTEL
- STYLE HOTEL ŞİŞLİ
- SULTAN SÜLEYMAN PALACE
- TAKSIM HILL HOTEL
- THE CENTRAL HOTEL
- THE CRATON HOTEL
- THE HALICH HOTEL
- THE TIME HOTEL
- TREND HOTEL
- ÜMİT HOTEL
- VATAN ASUR HOTEL
- VICTORY HOTEL
- WEIN GARD HOTEL
- WHITE MONARCH HOTEL
- WYNDHAM HOTEL
- VIA SPORT HOTEL
- YILSAM SULTANAHMET HOTEL
- YUVAM HOTEL



HOTEL TEXTILE PRODUCTS

HOTEL TEXTILE PRODUCTS



ASKLEPIOS asklepios series

towel

100% Cotton
Colour: Brown / Blue
16/1 Pile ring spun
20/2 Warp ring spun
16/1 Weft ring spun
Double stitching
Maximum water-absorbing



50x90 cm
200 gr./pc.
450 gsm



70x140 cm
400 gr./pc.
410 gsm



90x150 cm
600 gr./pc.
450 gsm



TALIA talia series

bathroom mat

- 100% Cotton
- Colour: White
- 20/2 Pile ring spun
- 20/2 Warp ring spun
- 20/2 Weft ring spun
- Double stitching
- Maximum water-absorbing

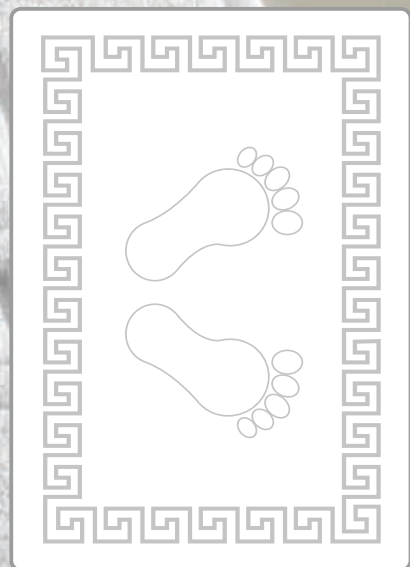

50x70cm



IPERION iperion series

towel

100% Cotton
Colour: White
20/2 Pile ring spun
20/2 Warp ring spun
16/1 Weft ring spun
Double stitching
Maximum water-absorbing



50x90 cm
225 gr./pc.
500 gsm



70x140 cm
450 gr./pc.
460 gsm



90x150 cm
600 gr./pc.
450 gsm



KRONOS kronos series

towel

- 100% Cotton
- Colour: White
- 16/2 Pile ring spun
- 20/2 Warp ring spun
- 16/1 Weft ring spun
- Double stitching
- Maximum water-absorbing



50x90 cm
300 gr./pc.
665 gsm



70x140 cm
600 gr./pc.
610 gsm

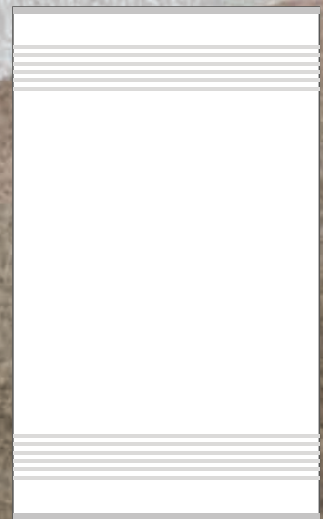

90x150 cm
800 gr./pc.
590 gsm



NEMESIS nemesis series

bathrobe

100% Cotton
Colour: White
20/2 Warp ring spun
16/1 Weft ring spun 210gsm
Maximum water-absorbing



EROS eros series

bathrobe

100% Cotton
Colour: White
16/1 Pile ring spun
20/2 Warp ring spun
16/1 Weft ring spun
330 gsm-400 gsm
Maximum water-absorbing



POSEIDON poseidon series

bathrobe

100% Cotton Velvet

Colour: White

16/1 Pile ring spun

20/2 Warp ring spun

16/1 Weft ring spun

330 gsm-400 gsm

Maximum water-absorbing



ORFE orfe series

bathrobe

100% Cotton

Colour: White

16/1 Pile ring spun

20/2 Warp ring spun

16/1 Weft ring spun

210gsm

Maximum water-absorbing



RISUS risus series

100% Cotton

Colour: White

Warp: 40/1 Compact Combed

Weft: 40/1 Compact Combed

51 warp x 32 weft

125 gsm - 210 TC

0.5 cm stripes

4/1 weaving

duvet cover

160x220cm - 200x220cm - 220x240cm

bedsheet

160x240cm - 200x240cm - 180x280cm - 240x280cm - 280x280cm

pillowcase

50x70cm - 70x70cm - 50x70+5cm

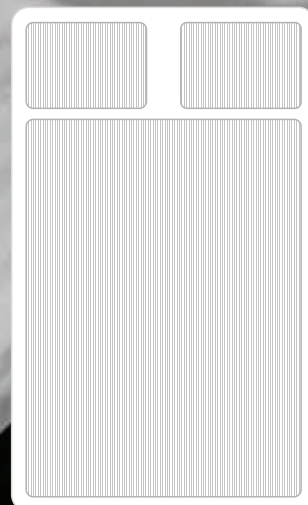

PAN pan series

100% Cotton

Colour: White

Warp: 30/1 thread

Weft: 30/1 thread

33 warp x 30 weft

125 gsm - 160 TC

Rain forced

1/1 weaving

duvet cover

160x220cm - 200x220cm - 220x240cm

bedsheet

160x240cm - 200x240cm - 180x280cm - 240x280cm - 280x280cm

pillowcase

50x70cm - 70x70cm - 50x70+5cm

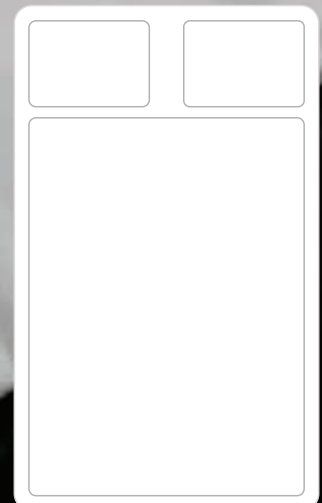

ERIS eris series

100% Cotton

Colour: White

Warp: 40/1 Compact Combed

Weft: 40/1 Compact Combed

51 warp x 32 weft

125 gsm - 210 TC

plain satin

4/1 weaving

duvet cover

160x220cm - 200x220cm - 220x240cm

bedsheet

160x240cm - 200x240cm - 180x280cm - 240x280cm - 280x280cm

pillowcase

50x70cm - 70x70cm - 50x70+5cm

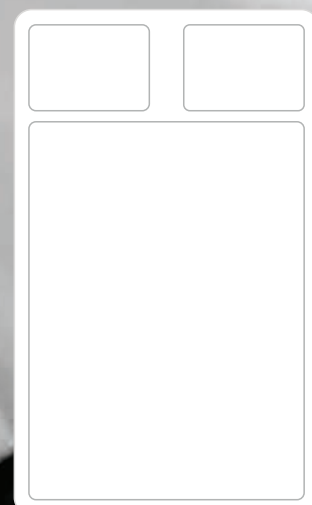

ZEUS zeus series

100% Cotton

Colour: White

Warp: 40/1 Compact Combed

Weft: 40/1 Compact Combed

51 warp x 32 weft

125 gsm - 210 TC

1 cm stripes

4/1 weaving

duvet cover

160x220cm - 200x220cm - 220x240cm

bedsheet

160x240cm - 200x240cm - 180x280cm - 240x280cm - 280x280cm

pillowcase

50x70cm - 70x70cm - 50x70+5cm

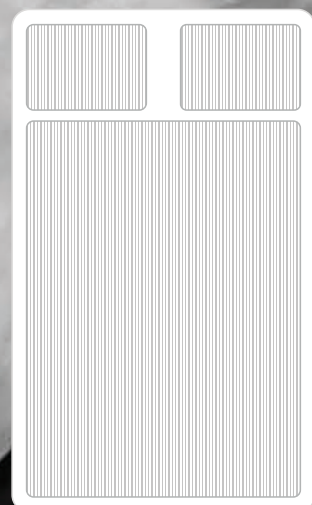

FEBRIS febris series

100% Cotton

Colour: White

Warp: 40/1 Compact Combed

Weft: 40/1 Compact Combed

51 warp x 32 weft

125 gsm - 210 TC

square design

4/1 weaving

duvet cover

160x220cm - 200x220cm - 220x240cm

bedsheet

160x240cm - 200x240cm - 180x280cm - 240x280cm - 280x280cm

pillowcase

50x70cm - 70x70cm - 50x70+5cm

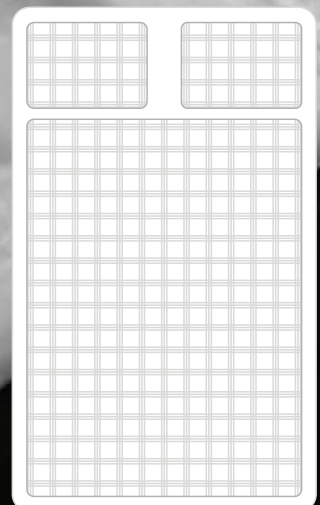

BUSSOLA
bussola series

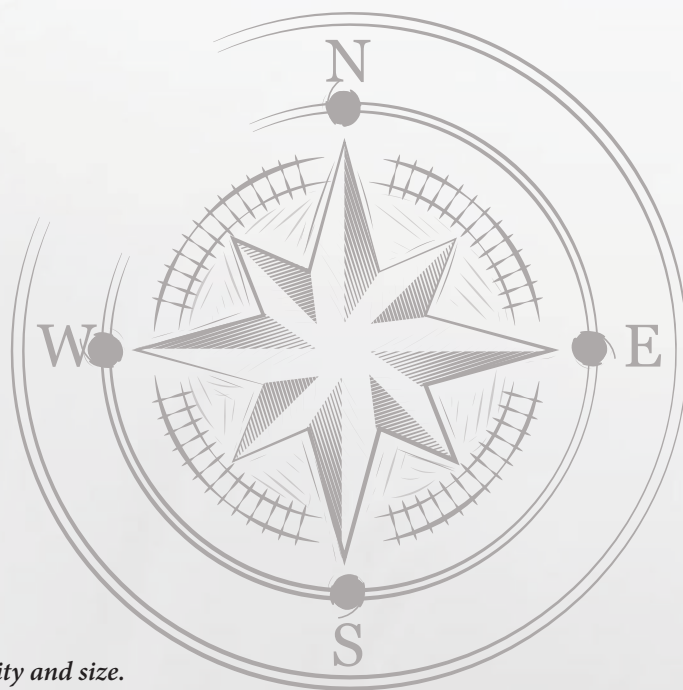

Your custom orders are produced according to the required quality and size.



ANKYRA
ankyra series



Your custom orders are produced according to the required quality and size.

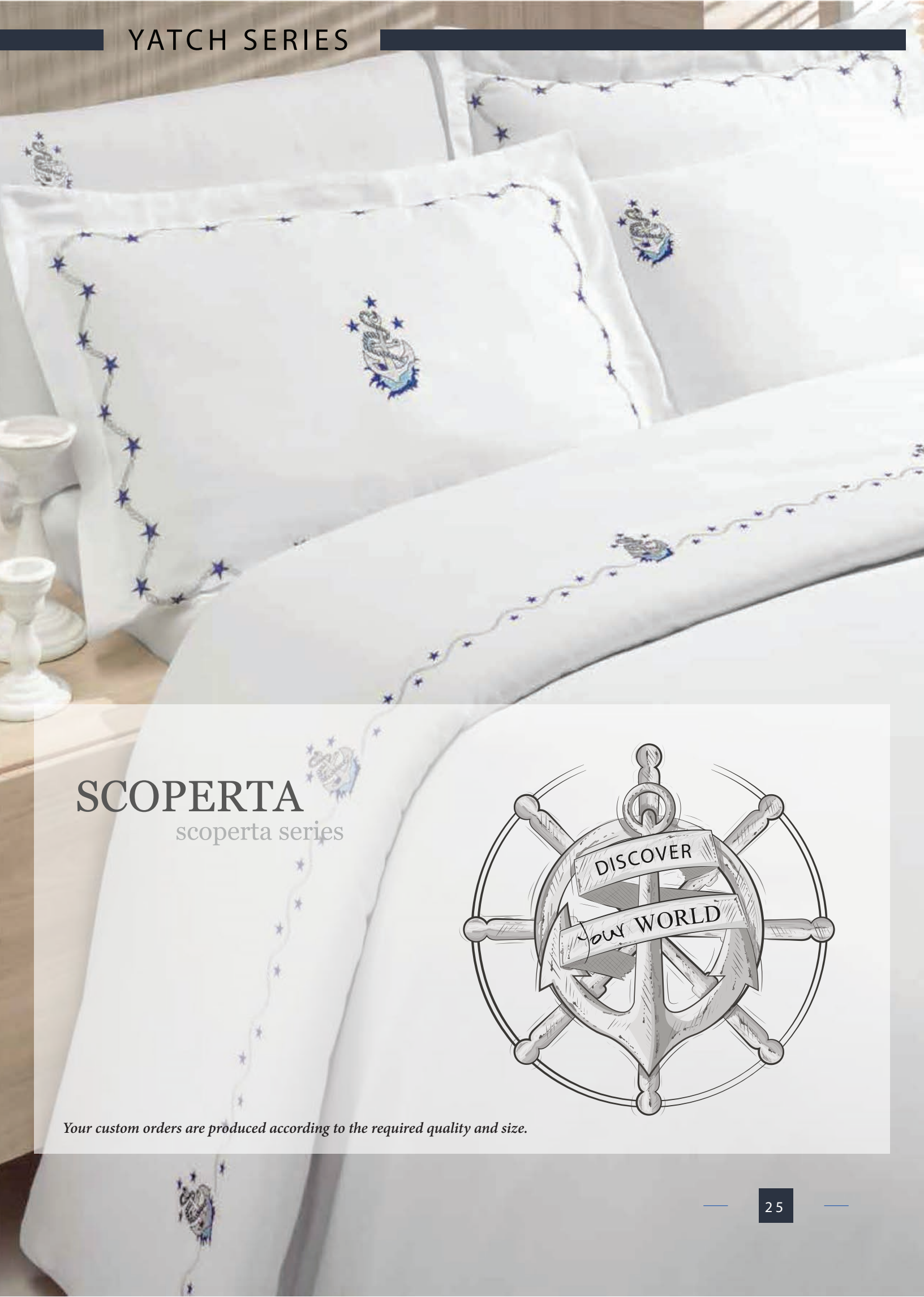

SCOPERTA
scoperta series



Your custom orders are produced according to the required quality and size.

ANEMON *anemon series*

100% Cotton
Colour: White
Warp: 20/2 ring spinning
Weft: 10/2 ring spinning
22 warp x 15 weft
300 gsm

pique
160x230cm - 200x230cm

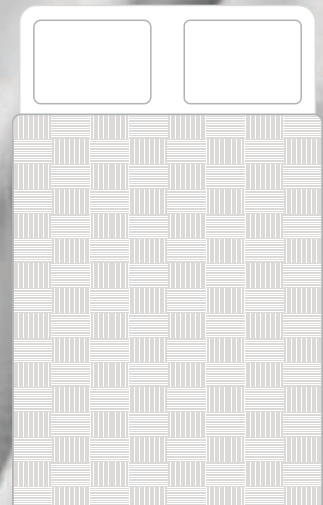

ARIEN arien series

100% Cotton
Colour: White
Warp: 30/2 ring spinning
Weft: 8/3 ring spinning
42 warp x 24 weft
320gsm

pique
160x230cm - 200x230cm

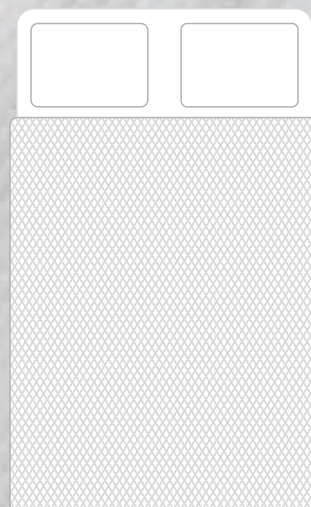

EOLO eolo series

blanket

100% Polar Fleece

Color: Different colors

250 gsm-300 gsm

Colors



1 2 3 4 5 6 7 8 9 10



160x220cm - 180x220cm
250 gr./m² - 300 gr./m²

BOREAS boreas series

blanket

%10 Cotton %90 Acrylic

Colors



1

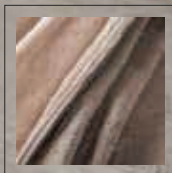

2

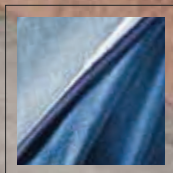

3

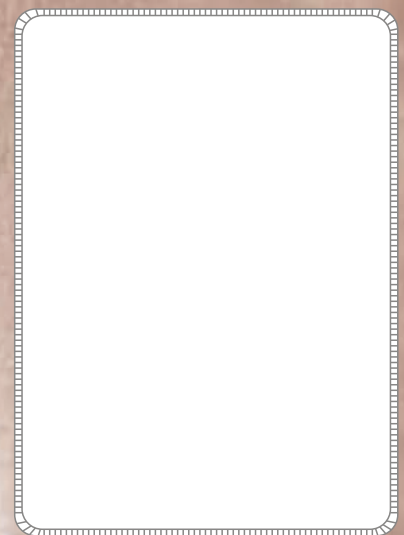

160x220cm - 180x220cm

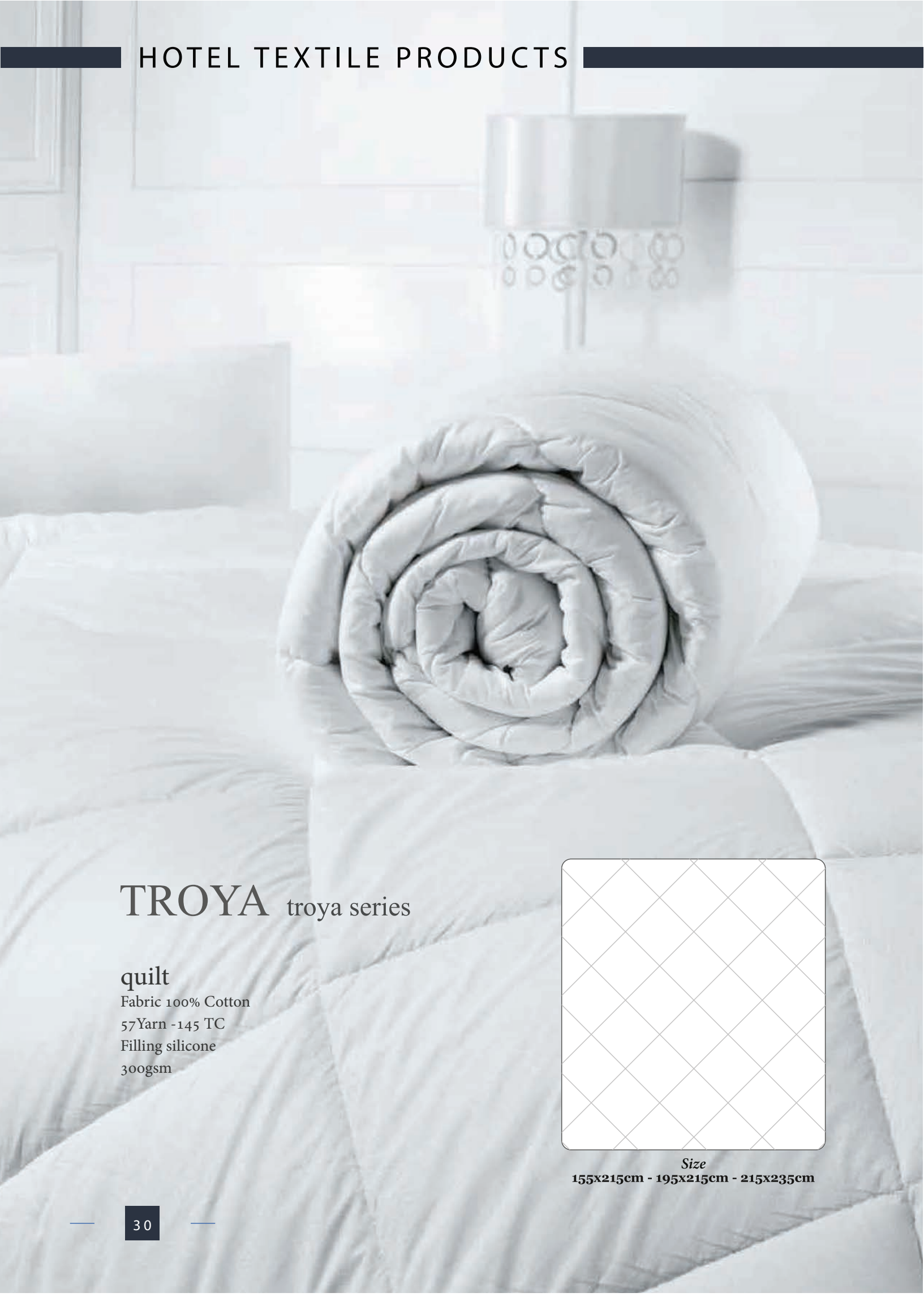

TROYA troya series

quilt

Fabric 100% Cotton

57Yarn -145 TC

Filling silicone

300gsm

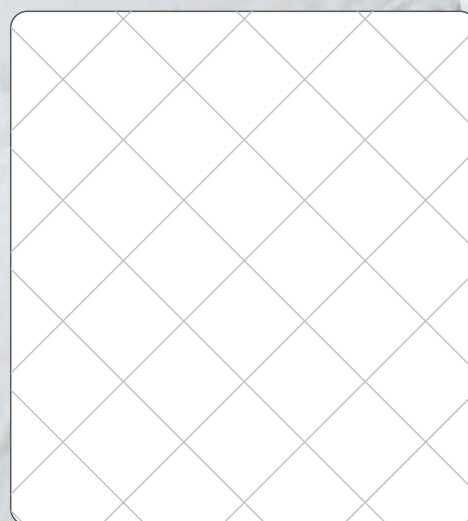

Size
155x215cm - 195x215cm - 215x235cm

FLORA flora series

quilt

Fabric 100% Polyester

Microfiber 85 gsm

Filling silicone

300 gsm

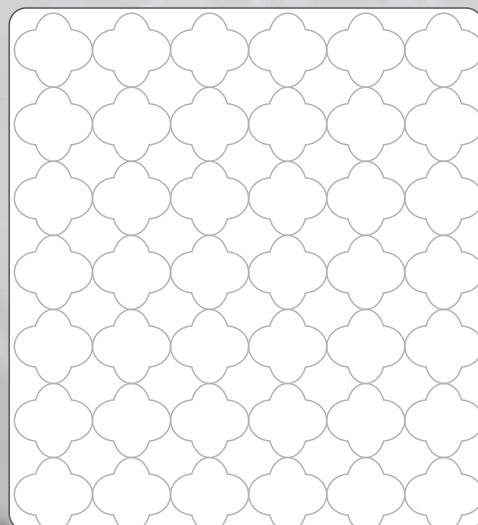

Size

155x215cm - 195x215cm - 215x235cm

PILLOW TYPES

STANDARD	HIGH	COMFORT
<p>Top Fabric 100% Cotton Filling Hollow fibre 800 gr / pc. Standard usage.</p>	<p>Top Fabric 100% Cotton Filling Hollow fibre 950 gr / pc. High pillow.</p>	<p>Top Fabric 100% Cotton Filling silicone N anogel 1100 gr / pc. Comfortable to use.</p>

NATURAL	HYGIENE	ORTHOPEDIC
<p>Top Fabric 100% Cotton Filling 100% Cotton 1000 gr / pc. Natura} pillows.</p>	<p>Top Fabric 100% Cotton Filling Hollow fibre 950 gr / pc. High pillow.</p>	<p>Top fabric 100% Bamboo Filling Viscom 40x60 + 5cm Orthopedic pillows.</p>

SUPPORT	COOL	COMFORTABLE
<p>Top fabric 100% Bamboo Filling Visco 36x60 + 12cm Neck support pillow.</p>	<p>Cool Tech Coatings Filling Visco 40x60 + 5cm Cool pillow.</p>	<p>Top Fabric 100% Cotton Filling goosedown 1000 gr / pc. Comfortable to use.</p>



PILLOW TYPES





CLEONE cleone series

mattress pad

Double Face Fabric
Microfiber & soft touch.
Filling silicone

90x190cm - 90x200cm - 100x200cm - 120x200cm - 140x200cm
160x200cm - 180x200cm - 200x200cm

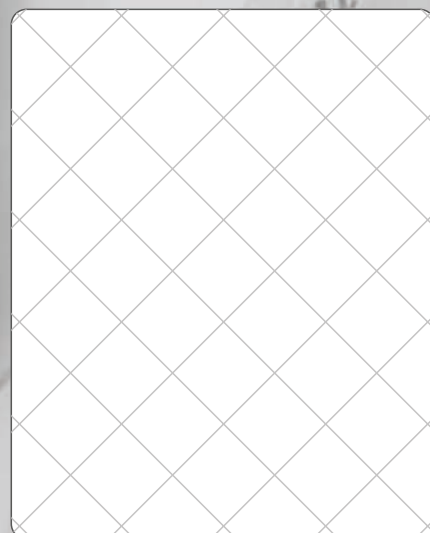

NELLIS nellis series

waterproof mattress protector

80% Cotton Fabric

20% Polyester

Polyurethane coating

145gsm

**90x190cm - 90x200cm - 100x200cm - 120x200cm - 140x200cm
160x200cm - 180x200cm - 200x200cm**

OLEISIA oleisia series

quilted mattress protector

100% Cotton Fabric

Filling silicone

90gsm

90x190cm - 90x200cm - 100x200cm - 120x200cm - 140x200cm
160x200cm - 180x200cm - 200x200cm

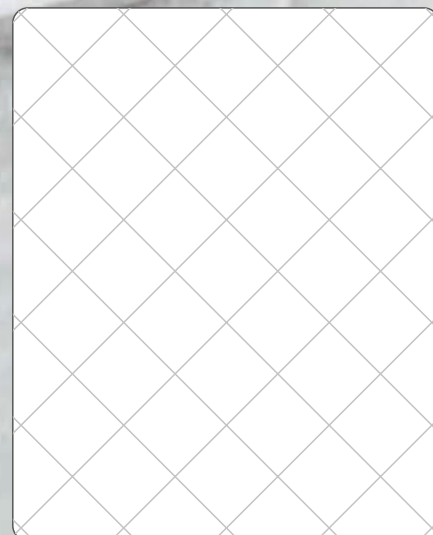

HOTEL TEXTILE PRODUCTS

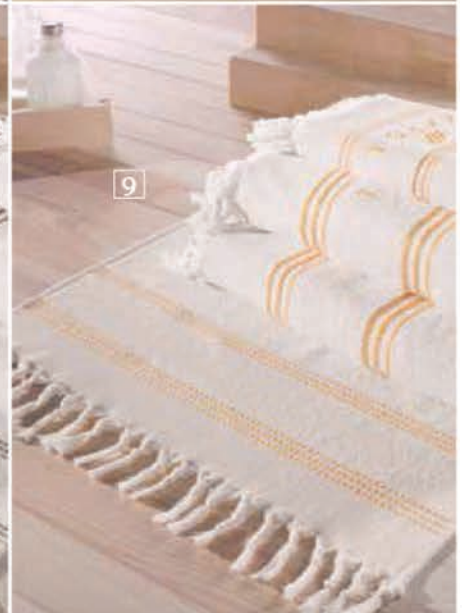



HOTEL CURTAINS AND PRODUCTS



HOTEL CURTAINS AND PRODUCTS



HOTEL CURTAINS - ST125



HOTEL CURTAINS - ST128



HOTEL CURTAINS - ST121



HOTEL CURTAINS - ST123



HOTEL CURTAINS - ST122



HOTEL CURTAINS - ST132

HOTEL CURTAINS AND PRODUCTS



HOTEL CURTAINS - ST133



HOTEL CURTAINS - ST135



HOTEL CURTAINS - ST137



HOTEL CURTAINS - ST138



HOTEL CURTAINS - ST140



HOTEL CURTAINS - ST127

HOTEL CURTAINS AND PRODUCTS



HOTEL CURTAINS - ST141



HOTEL CURTAINS - ST143



HOTEL CURTAINS - ST145



HOTEL STOR ZEBRA - ST265



HOTEL STOR ZEBRA - ST268



HOTEL STOR ZEBRA - ST269

HOTEL CURTAINS AND PRODUCTS



HOTEL THROW BED SHAWL



HOTEL THROW BED SHAWL



HOTEL STOR - ST263



HOTEL TULLE CURTAINS - ST025



HOTEL TULLE CURTAINS - ST027



HOTEL TULLE CURTAINS - ST029



BEDS & BASES





BETİLİ

MATTRESS CONTENT INFO

1. **LARGE WOVEN FABRIC**
2. **150 gr/m² SILICONE MIXED FIBER- 215 cm**
3. **17 mm D22 ROLL FOAM - 210 cm**
4. **17 mm D22 ROLL FOAM - 210 cm**
5. **30 gr/m² WHITE INTERLINING FABRIC - 230 cm**
6. **1600 gr FELT - 157x197 cm**
7. **1600 gr FELT - 157x197 cm**
8. **MULTI-SPRING SYSTEM - 138x190x13,5 cm**
9. **1600 gr FELT - 157x197 cm**
10. **1600 gr FELT - 157x197 cm**
11. **D28 FOAM PLATE - SOFT - 10x14x187 cm**

1. **D28 FOAM PLATE - SOFT - 5x14x157 cm**
2. **LARGE WOVEN FABRIC**
3. **150 gr/m² SILICONE FILLED FIBER - 215 cm**
4. **17 mm D22 ROLL FOAM - 210 cm**
5. **17 mm D22 ROLL FOAM - 210 cm**
6. **30 gr/m² WHITE INTERLINING FABRIC - 230 cm**
7. **17 mm D22 ROLL FOAM - 210 cm**
8. **CHECKERED WOVEN FABRIC**
9. **90 gr/m² NON-SILICONE FIBER - 215 cm**
10. **8 mm D15 AG ROLL FOAM - 210 cm**
11. **30 gr/m² WHITE INTERLINING FABRIC - 230 cm**



MEDIUM FIRM



26 cm



Multi-spring System



Woven Fabric





RENAISSANCE

MATTRESS CONTENT INFO

1. *QUEEN FR FABRIC - 225 cm*
2. *150 gr/m² SILICONE MIXED FIBER - 215 cm*
3. *17 mm D22 ROLL FOAM - 210 cm*
4. *17 mm D26 HYPER ROLL FOAM - 215 cm*
5. *30 gr/m² WHITE INTERLINING FABRIC - 230 cm*
6. *D26 HYPER FOAM PLATE - 3x157x197 cm*
7. *1000 gr FELT- 157x197 cm*
8. *5-ZONE POCKET SPRING SYSTEM - 147x185x13,5 cm*
9. *1000 gr FELT - 157x197 cm*
10. *D28 SOFT FOAM PLATE - 10x13,5x183 cm*

1. *D28 SOFT FOAM PLATE - 7x13,5x157 cm*
2. *QUEEN FR FABRIC - 225 cm*
3. *150 gr/m² SILICONE MIXED FIBER - 215 cm*
4. *17 mm D22 ROLL FOAM - 210 cm*
5. *17 mm D26 HYPER ROLL FOAM - 215 cm*
6. *30 gr/m² WHITE INTERLINING FABRIC - 230 cm*
7. *SATIN FABRIC*
8. *8 mm D15 AG ROLL FOAM - 210 cm*
9. *30 gr/m² WHITE INTERLINING FABRIC - 230 cm*



**MEDIUM
FIRM**



26 cm



**5 Zone Pocket
Spring System**



**Hyper
Foam**





SWITZERLAND

MATTRESS CONTENT INFO

1. SAND PATTERN JERSEY FABRIC - 230 cm
2. 150 gr/m² SILICONE MIXED FIBER- 215 cm
3. 17 mm D26 WHITE HYPER FOAM - 215 cm
4. 17 mm D22 ROLL FOAM - 210 cm
5. 30 gr/m² WHITE INTERLINING FABRIC - 230 cm
6. D28 FIRM FOAM PLATE - 2x157x197 cm
7. 1000 gr FELT - 157x197 cm
8. 600 gr FELT - 157x197 cm
9. 5-ZONE POCKET SPRING SYSTEM - 147x178x13,5 cm
10. 600 gr FELT - 157x197 cm
11. 1000 gr FELT - 157x197 cm

1. D28 SOFT FOAM PLATE - 10x13,5x183 cm
2. D28 FIRM FOAM PLATE - 2x157x197 cm
3. SAND PATTERN JERSEY FABRIC - 230 cm
4. 150 gr/m² SILICONE MIXED FIBER - 215 cm
5. 17 mm D26 HYPER ROLL FOAM - 215 cm
6. 17 mm D22 ROLL FOAM - 210 cm
7. 30 gr/m² WHITE INTERLINING FABRIC - 230 cm
8. 230 cm SAND PATTERN JERSEY FABRIC
9. 90 gr/m² NON-SILICONE FIBER - 215 cm
10. 8 mm D15 AG ROLL FOAM - 210 cm
11. 30 gr/m² WHITE INTERLINING FABRIC - 230 cm



FIRM



26 cm



5 Zone Pocket Spring System



Hyper Foam





QUASAR

MATTRESS CONTENT INFO

1. 280 gr/m² QUEEN FABRIC - 225 cm
2. 300 gr/m² WOOLY FILLED FIBER - 220 cm
3. 17 mm D26 WHITE HYPER ROLL FOAM - 215 cm
4. 30 gr/m² WHITE INTERLINING FABRIC - 230 cm
5. D22 FOAM PLATE 2x157x197 cm
6. 200 gr WHITE ROLL FELT - 197 cm
7. D28 SOFT FOAM 11x19x157 cm
8. D28 SOFT FOAM 8x19x175 cm
9. POCKET SPRING SYSTEM 1410x1820x200 mm

1. 200 gr WHITE ROLL FELT - 197 cm
2. 30 gr/m² WHITE INTERLING FABRIC - 230 cm
3. D26 WHITE HYPER ROLL FOAM - 215 cm
4. 300 gr/m² WOOLY SILCONE FILLED FIBER - 220 cm
5. 280 gr/m² QUEEN FABRIC - 225 cm
6. 280 gr/m² QUEEN FABRIC - 225 cm
7. 90 gr/m² NON-SILICONE MIXED FIBER
8. 8 mm D15 AG ROLL FOAM - 210x0,8 cm
9. 30 gr/m² WHITE INTERLINING FABRIC - 220 cm



MEDIUM FIRM



31 cm



Pocket Spring System



Hyper Foam





PLATINIUM

MATTRESS CONTENT INFO

1. SAND PATTERN JERSEY FABRIC - 230 cm
2. 150 gr/m² SILICONE MIXED FIBER- 215 cm
3. 17 mm D26 WHITE HYPER ROLL FOAM - 215 cm
4. 17 mm D22 ROLL FOAM - 210 cm
5. 17 mm D26 WHITE HYPER ROLL FOAM - 215 cm
6. 30 gr/m² WHITE INTERLINING FABRIC - 230 cm
7. 1600 gr FELT - 157x197 cm
8. 1600 gr FELT - 157x197 cm
9. MULTI-SPRING SYSTEM - 138x190x13,5 cm
10. 1600 gr FELT- 157x197 cm
11. 1600 gr FELT - 157x197 cm

1. D28 FOAM PLATE - SOFT - 10x14x187 cm
2. D28 FOAM PLATE - SOFT - 5x14x157 cm
3. SAND PATTERN JERSEY FABRIC - 230 cm
4. 150 gr/m² SILICONE MIXED FIBER- 215 cm
5. 17 mm D22 ROLL FOAM - 210 cm
6. 17 mm D26 WHITE HYPER ROLL FOAM - 215 cm
7. 30 gr/m² WHITE INTERLINING FABRIC - 230 cm
8. SAND PATTERN JERSEY FABRIC - 230 cm
9. 90 gr/m² NON-SILICONE FIBER - 215 cm
10. 8 mm D15 AG ROLL FOAM - 210 cm
11. 30 gr/m² WHITE INTERLINING FABRIC - 230 cm



FIRM



30 cm



**Multi-spring
Spring System**



**Hyper
Foam**





CALIFORNIA

MATTRESS CONTENT INFO

1. 280 gr/m² QUEEN FABRIC - 225 cm
2. 150 gr/m² SILICONE MIXED FIBER - 215 cm
3. 17 mm D26 WHITE HYPER ROLL FOAM - 215 cm
4. 17 mm D26 WHITE HYPER ROLL FOAM - 215 cm
5. 17 mm D26 WHITE HYPER ROLL FOAM - 215 cm
6. 30 gr/m² WHITE INTERLINING FABRIC - 230 cm
7. D22 FOAM PLATE - 2x157x197 cm
8. 600 gr SOFT FELT - 157x197 cm
9. MIRACOIL SPRING SYSTEM - 138x185x14,5 cm
10. D28 SOFT FOAM PLATE - 10x14,5x186 cm
11. D28 SOFT FOAM PLATE - 5,5x14,5x157 cm

1. 600 gr SOFT FELT - 157x197 cm
2. D22 FOAM PLATE - 2x157x197 cm
3. 280 gr/m² QUEEN FABRIC - 225 cm
4. 150 gr/m² SILICONE MIXED FIBER - 215 cm
5. 17 mm D26 WHITE HYPER ROLL FOAM - 215 cm
6. 17 mm D26 WHITE HYPER ROLL FOAM - 215 cm
7. 17 mm D26 WHITE HYPER ROLL FOAM - 215 cm
8. 30 gr/m² WHITE INTERLINING FABRIC - 230 cm
9. SATURN OPTIC MATTRESS FABRIC
10. 8 mm D15 AG ROLL FOAM - 210 cm
11. 30 gr/m² WHITE INTERLINING FABRIC - 230 cm



MEDIUM FIRM



32 cm



Mira-Coil Spring System



Hyper Foam





VEGAS DREAM

MATTRESS CONTENT INFO

1. SILVER WAVE PATTERN FABRIC - 235 cm
2. 300 gr/m² WOOLY SILICONE MIXED FIBER
3. 300 gr/m² WOOLY SILICONE MIXED FIBER
4. 17 mm D26 WHITE HYPER ROLL FOAM - 215 cm
5. 30 gr/m² WHITE INTERLINING FABRIC - 230 cm
6. VISCO GEL FOAM PLATE - 2x157x197 cm
7. VISCO FOAM PLATE - 5x157x197 cm
8. FIRM VIOLE FOAM PLATE - 2,5x157x197 cm
9. D18 FOAM PLATE - 1,5x157x197 cm
10. 200 gr WHITE ROLL FELT - 197 cm

1. POCKET SPRING SYSTEM - 141x182x20 cm
2. D28 SOFT FOAM - 11x19x157 cm
3. D28 SOFT FOAM - 8x19x175 cm
4. 200 gr WHITE ROLL FELT - 197 cm
5. 5 mm D15 AG ROLL FOAM - 210 cm
6. 15 gr/m² WHITE INTERLINING FABRIC - 230 cm
7. SATIN WHITE FABRIC
8. 90 gr/m² SILICONE MIXED FIBER
9. 5 mm D15 AG ROLL FOAM - 210 cm
10. 30 gr/m² BEYAZ TELA KUMAŞ - 230 cm



MEDIUM FIRM



35 cm



Pocket Spring Sytem



Hyper Foam



Visco Gel



Viyol Foam





CEREMONIE

MATTRESS CONTENT INFO

- | | |
|---|--|
| 1. PERU PICCHU 4X4 POCKET PATTERN FABRIC | 1. 1000 gr/m ² FELT |
| 2. 250 gr/m ² SILICONE MIXED FIBER | 2. 30 mm D22 ROLL FOAM - 215 cm |
| 3. 300 gr/m ² SILICONE MIXED FIBER | 3. D26 FIRM FRAME FOAM |
| 4. 17 mm D26 WHITE HYPER ROLL FOAM - 215 cm | 4. FLAT GREY FABRIC |
| 5. 17 mm D22 ROLL FOAM - 215 cm | 5. 5 mm D15 AG ROLL FOAM - 210 cm |
| 6. 30 gr/m ² WHITE INTERLINING FABRIC - 230 cm | 6. 15 gr/m ² WHITE INTERLINING FABRIC - 230 cm |
| 7. 17 mm D26 WHITE HYPER ROLL FOAM - 215 cm | 7. VANILLA FABRIC |
| 8. 24 mm D28 SOFT ROLL FOAM - 215 cm | 8. 90 gr/m ² SILICONE MIXED FIBER |
| 9. 11000 gr/m ² FELT | 9. 8 mm D15 AG ROLL FOAM - 210 cm |
| 10. MIRA-COIL SPRING SYSTEM - 2,4x13,5 cm - 185 pcs /m ² | 10. 30 gr/m ² WHITE INTERLINING FABRIC - 230 cm |



MEDIUM FIRM



30 cm



Mira-Coil Spring System



Hyper Foam



Extra Mattress Topper





ANTARES

MATTRESS CONTENT INFO

1. %100 PES FABRIC - 220 cm

2. D50 VISCO GEL FOAM - 5x100x200 cm

3. D35 HR FIRM FOAM - 15x100x200 cm

1. D22 FOAM - 5x100x200 cm

2. 248 gr/m² ANTISLIP MATTRESS FABRIC - 213 cm

3. %100 GUSSET FABRIC - 220 cm



MEDIUM FIRM



26 cm



Visco Gel Foam





SMYRNA

MATTRESS CONTENT INFO

1. 280 gr/m² RAMA MATTRESS FABRIC - 235 cm
2. D35 FLEXI PROFILE FOAM 2,5x177x197cm
3. D35 HR SOFT FOAM 5x177x197cm
4. 1000 gr/m² FELT - 177x197 cm
5. POCKET SPRING SYSTEM - 87x197x15 cm
6. D26 FIRM FOAM - 8x15x183 cm
7. D26 FIRM FOAM - 7x15x177 cm
8. 1000 gr/m² FELT - 177x197 cm

1. D22 FOAM PLATE - 2x177x197 cm
2. CHECKERED FABRIC - 220 cm
3. 8 mm D15 AG ROLL FOAM - 210 cm
4. 30 gr/m² WHITE INTERLINING FABRIC - 230 cm
5. 280 gr/m² RAMA MATTRESS FABRIC - 235 cm
6. 150 gr/m² SILICONE MIXED FABRIC - 235 cm
7. 5 mm D15 AG ROLL FOAM - 210 cm
8. 15 gr/m² WHITE INTERLINING FABRIC - 230 cm



**MEDIUM
FIRM**



30 cm



**Pocket
Spring
System**



**Extra Mattress
Topper**





ANATOLIA

MATTRESS CONTENT INFO

1. 280 gr/m² QUEEN FABRIC - 225 cm
2. 150 gr/m² SILICONE MIXED FIBER
3. 17 mm D26 WHITE HYPER ROLL FOAM - 215 cm
4. 17 mm D26 WHITE HYPER ROLL FOAM - 215 cm
5. 30 gr/m² WHITE INTERLINING FABRIC - 230 cm
6. D50 VISCO FOAM - 3,3x157x197 cm
7. 200 gr/m² WHITE FELT ROLL 197 cm
8. MIRA-COIL SPRING SYSTEM - 77x185x14,5
9. D26 FIRM FOAM PLATE - 10x14,5x186 cm
10. D26 FIRM FOAM PLATE - 10x14,5x186 cm

1. 200 gr/m² WHITE FELT ROLL 197 cm
2. LATEX FOAM - 14x120x200 cm
3. 150 gr/m² SILICONE MIXED FIBER
4. 17 mm D26 WHITE HYPER ROLL FOAM - 215 cm
5. 17 mm D26 WHITE HYPER ROLL FOAM - 215 cm
6. 15 gr/m² WHITE INTERLINING FABRIC - 230 cm
7. 280 gr/m² QUEEN FABRIC - 225 cm
8. 90 gr/m² SILICONED MIX FABRIC - 215 cm
9. 8 mm D15 AG RULO FOAM - 210 cm
10. 30 gr/m² WHITE INTERLINING FABRIC - 230 cm



**MEDIUM
FIRM**



32 cm



**Mira-Coil
Spring System**



**Hyper
Foam**



**Visco
Foam**



**Latex
Foam**



FITTED TOPPER

DOUBLE COMFORT ON SINGLE BEDS!

It is now very easy to experience the comfort of a double bed in two single beds. Get ready for an extraordinary sleep experience thanks to the fitted mattress topper.





FOLDED BED



PRACTICAL & COMFORTABLE

EASY PORTABLE DESIGN THAT CAN BE OPENED WITH EVEN ONE HAND...

FOLDED BED - DIMENSION

1. 80x190 cm

2. 90x200 cm

3. 100x200 cm

SPRING BOX

FLEXIBILITY, COMFORT, AND PERFORMANCE...



CONNECTING METAL APPARATUS

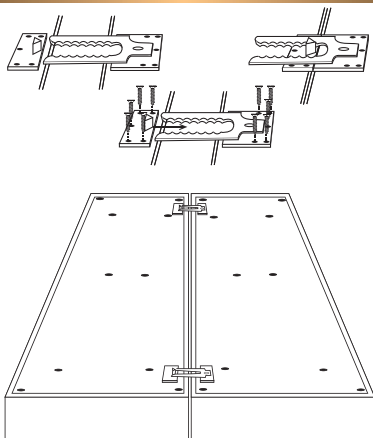

BOX HEIGHT DIMENSION (cm)
20 cm

DIMENSION (cm)	DIMENSION (cm)
80x200 cm	140x200 cm
90x200 cm	150x200 cm
100x200 cm	150x200 cm (2P)
110x200 cm	160x200 cm
120x200 cm	160x200 cm (2P)
130x190 cm	180x200 cm
140x190 cm (2P)	180x200 cm (2P)
140x190 cm	200x200 cm (2P)



VERTICAL BOX

SAVES SPACE...

DIMENSION (cm)
90x190 cm
90x200 cm

POLY BOX



FEEL THE POWER AND COMFORT!



CONNECTING CLIPS

You can easily connect two single YATSAN Poly Boxes from the top with its connecting clips, without using screws or similar joining materials.

BOX HEIGHT - DIMENSION (cm)	DIMENSION (cm)	DIMENSION (cm)
14 cm	80x200 cm	140x200 cm
20 cm	90x200 cm	150x200 cm
	100x200 cm	150x200 cm (2P)
	110x200 cm	160x200 cm
	120x200 cm	160x200 cm (2P)
	130x190 cm	180x200 cm
	140x190 cm (2P)	180x200 cm (2P)
	140x190 cm	200x200 cm (2P)

NEW ELITE BOX



ELITE, AESTHETIC AND PRACTICAL!



CONNECTING CLIPS

You can easily connect two single YATSAN Poly Boxes from the top with its connecting clips, without using screws or similar joining materials.

BOX HEIGHT DIMENSION (cm)	DIMENSION (cm)	DIMENSION (cm)
14 cm	80x200 cm	140x200 cm
20 cm	90x200 cm	150x200 cm
	100x200 cm	150x200 cm (2P)
	110x200 cm	160x200 cm
	120x200 cm	160x200 cm (2P)
	130x190 cm	180x200 cm
	140x190 cm (2P)	180x200 cm (2P)
	140x190 cm	200x200 cm (2P)

STAR DAYBED SOFA

MODEST WITH ITS SIMPLICITY, ASSERTIVE WITH ITS DESIGN...



KALINA CORNER SET

ELITE, AESTHETIC, AND PRACTICAL





IN-ROOM EQUIPMENT



IN-ROOM EQUIPMENT

SM 40 BLOK

SM 40 CAM



Model	SM 40 Blok	SM 40 Glass
Net Volume (lt)	36	40
External Dimensions (HxWxD) mm.	557X408X454	557X408X454
Energy Consumption (kWh /)	1,20	1,40
Net weight	11,11	11,11
Noise Level	0 dB	0 dB
Features		
Cooling System	Absorption	Absorption
Led Light	No (Optional)	No (Optional)
Automatic Defrost	No	No
Reversible Door	Standard	Standard
Thermostat Control	Mechanic	Mechanic
1,5 Lt Bottle Holder	Yes	Yes
Raf	White Plastic	White Plastic



SM 40 ECO

The use of C-pentan (%100 environmentally friendly)
 Absorption Cooling Systems
 Led light (na)
 Automatic Defrost (optional)
 Reversible Door (standard)
 Curved door (standard)
 Thermostat control (mechanic)
 1,5 Lt Bottle Holder (yes)
 Transparent Shelves (white plastic)

Technical Specifications

Gross Volume (lt)	38 LT - 44 LT
Net Volume (lt)	33 LT - 40 LT
External Dimensions (Y x G x D) mm.	566x441x457
Packed Dimensions (Y x G x D) mm.	614x464x494
Compartment Type	Kiler/Cellar
Cooling System	Absorption
Energy Consumption (kWh / Annum)	230 - 430
Energy Efficiency Index	291
Climate Class	N (16° - 32°)
Storage Temperature CÂ°	8-14
Gross weight	13,30 kg - 17,20 kg
Net weight	12,00 kg - 15,90 kg
Power	60 W - 75 W
Power Supply	220 V or 240 V - 110 V or 230 V / 50-60 Hz
Container Loading Capacity 20' / 40' / 40'hc	165-360-480



SM 27 ECO

The use of C-pentan (%100 environmentally friendly)
 Absorption Cooling Systems
 Led light (na)
 Automatic Defrost (optional)
 Reversible Door (standard)
 Curved door (standard)
 Thermostat control (mechanic)
 1,5 Lt Bottle Holder (standard)
 Transparent Shelves (white plastic)

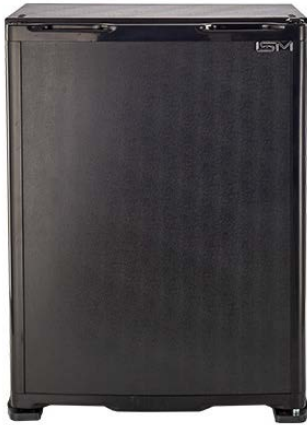

Technical Specifications

Gross Volume (lt)	24 LT -28 LT
Net Volume (lt)	21 LT- 24 LT
External Dimensions (Y x G x D) mm.	512x390x423
Packed Dimensions (Y x G x D) mm.	559x432x464
Compartment Type	Kiler/Cellar
Cooling System	Absorption
Energy Consumption (kWh / Annum)	226 - 526
Energy Efficiency Index	290-674
Climate Class	N (16° - 32°)
Storage Temperature C°	8-12
Gross weight	11,45 kg -14,90 kg
Net weight	10,15 kg - 13,60 kg
Power	60 W - 75 W
Power Supply	220 V or 240 V / 50-60 Hz
Container Loading Capacity 20' / 40' / 40'hc	260-520-520

SM 30 ECO

The use of C-pentan (%100 environmentally friendly)
 Absorption Cooling Systems
 Led light (na)
 Automatic Defrost (optional)
 Reversible Door (standard)
 Curved door (standard)
 Thermostat control (mechanic)
 1,5 Lt Bottle Holder (standard)
 Transparent Shelves (white plastic)



Technical Specifications

Gross Volume (lt)	30 LT
Net Volume (lt)	26 LT
External Dimensions (Y x G x D) mm.	512x419x423
Packed Dimensions (Y x G x D) mm.	559x442x464
Compartment Type	Kiler/Cellar
Cooling System	Absorption
Energy Consumption (kWh / Annum)	226 - 372
Energy Efficiency Index	288
Climate Class	N (16° - 32°)
Storage Temperature C°	8-14
Gross weight	11,80 kg - 15,50 kg
Net weight	10,50 kg - 14,20 kg
Power	60 W
Power Supply	220 V or 240 V - 110 V - 230 V / 50-60 Hz
Container Loading Capacity 20' / 40' / 40'hc	260-520-520

IN-ROOM EQUIPMENT



HOTEL TYPE TELEVISION

32 Inch



HOTEL TYPE TELEVISION

40 Inch

HOTEL ROOM SAFE BOXES

MODEL: S2-2C STANDARD

MODEL: T2-2C LAPTOP SIZE



Technical Specifications

Color: Ivory/Black

Option to rent from computer

HxWxD 220x400x420 mm

Body sheet thickness: 1,80mm

Door sheet thickness: 2,8mm

Motorized locking mechanism

6-digit digital display

4-6 digits user password identification

6 digit master password

Master switch (can be switched on in case of emergency)

Display / hide option on screen for entered password

Automatic locking with 4 incorrectly entered passwords

Being able to see the last 100 actions on the screen

Battery power status inquiry (weak, full)

Lower and rear mounting

Electrostatic powder coating against rust

Carpet on the product floor

4 batteries (The cover on the battery slots is screwed)

IN-ROOM EQUIPMENT



STM-140



STM-141



STM-142



STM-143

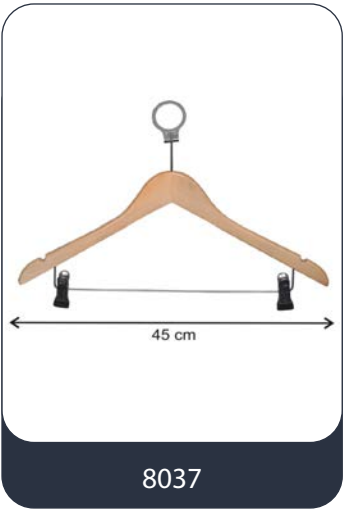

8037

WOODEN ANTI THEFT HANGER WITH METAL RING

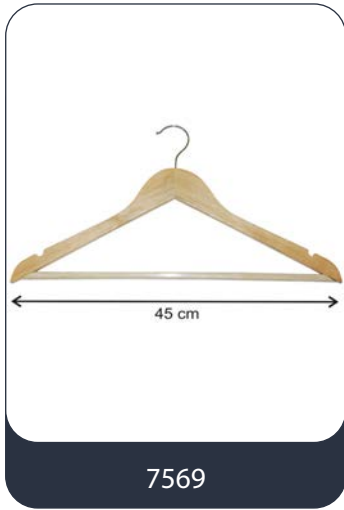

7569

WOODEN HOME TYPE HANGER

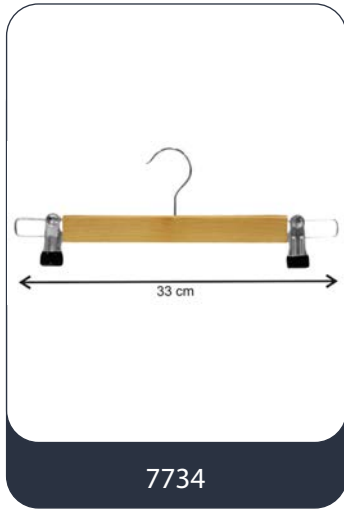

7734

WOODEN SKIRT HANGER WITH HOOK

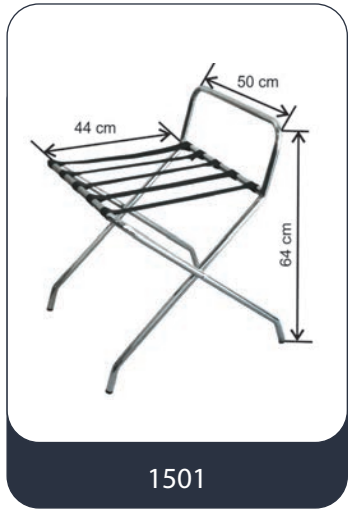

1501

PAINTED LUGGAGE RACK



7935

IRONING BOARD



8036

HOTEL TYPE IRONING FLOOR BASE 1500-2000 WATT



1503

PAINTED LUGGAGE RACK

IN-ROOM EQUIPMENT



7622

1.2 LT STAINLESS STEEL
KETTLE BLACK HANDLE



7005 | WONDER

WOODEN WELCOME TRAY



7006 | WONDER

WOODEN WELCOME TRAY
27x45x1,8 cm



7007 | WONDER

WOODEN AMENITY TRAY
7x45x1,8 cm



WALL SCONCE | ST458

PAINTED



WALL SCONCE | ST460

TUMBLED METAL



WALL SCONCE | ST461

CHROME



WALL SCONCE | ST462

PAINTED



1001 | 3 LT

3 LT PEDAL BIN



1002 | 5 LT

5 LT PEDAL BIN



1432 | 3 LT

3 LT STAINLESS STEEL WASTE
BIN WITH INTERIOUR BUCKET
AND RING



1433 | 5 LT

5 LT STAINLESS STEEL WASTE
BIN WITH INTERIOUR BUCKET
AND RING

HOTEL RESTAURANT PRODUCTS



HOTEL RESTAURANT PLATES



HOTEL RESTAURANT BOWLS



HOTEL RESTAURANT PRODUCTS



HOTEL BAR ACCESSORY



HOTEL RESTAURANT GLASSES



HOTEL RESTAURANT SETS

HOTEL RESTAURANT PRODUCTS



HOTEL RESTAURANT SERVICE PRODUCTS



HOTEL RESTAURANT GLASS PRODUCTS



HOTEL RESTAURANT TABLE TEXTILE



CARPET, PARQUET AND WALLPAPER

CARPET, PARQUET AND WALLPAPER



HOTEL TYPE PARQUET- ST121



HOTEL TYPE PARQUET- ST123



HOTEL TYPE PARQUET- ST125

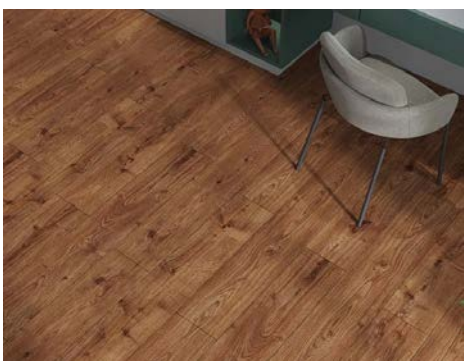

HOTEL TYPE PARQUET- ST126



HOTEL TYPE PARQUET- ST128



HOTEL TYPE PARQUET- ST129



HOTEL TYPE PARQUET- ST130



HOTEL TYPE PARQUET- ST132



HOTEL TYPE PARQUET- ST133



HOTEL TYPE PARQUET- ST134



HOTEL TYPE PARQUET- ST135



HOTEL TYPE PARQUET- ST136

CARPET, PARQUET AND WALLPAPER



HOTEL TYPE PARQUET- ST137



HOTEL TYPE PARQUET- ST138



HOTEL TYPE PARQUET- ST139



HOTEL TYPE PARQUET- ST142



HOTEL TYPE PARQUET- ST144



HOTEL TYPE PARQUET- ST145



HOTEL TYPE PARQUET- ST146



HOTEL TYPE PARQUET- ST147



HOTEL TYPE PARQUET- ST148



HOTEL TYPE PARQUET- ST151



HOTEL TYPE PARQUET- ST152



HOTEL TYPE PARQUET- ST154

CARPET, PARQUET AND WALLPAPER



WALL TO WALL CARPETS - ST586



WALL TO WALL CARPETS - ST583



WALL TO WALL CARPETS - ST581



WALL TO WALL CARPETS - ST580



WALL TO WALL CARPETS - ST591



WALL TO WALL CARPETS - ST592



WALL TO WALL CARPETS - ST562



WALL TO WALL CARPETS - ST564



WALL TO WALL CARPETS - ST832



WALL TO WALL CARPETS - ST833

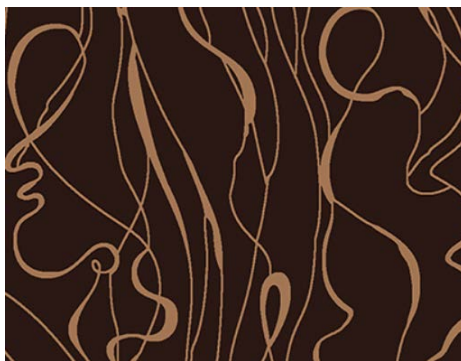

WALL TO WALL CARPETS - ST576

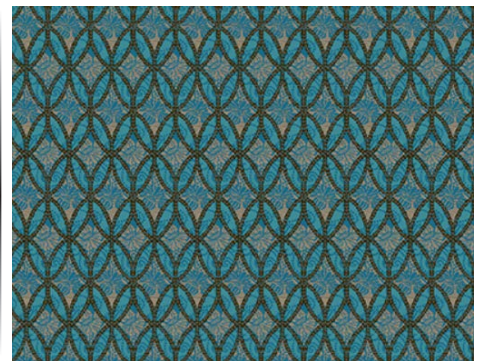

WALL TO WALL CARPETS - ST571



WALL TO WALL CARPETS - ST425



WALL TO WALL CARPETS - ST432

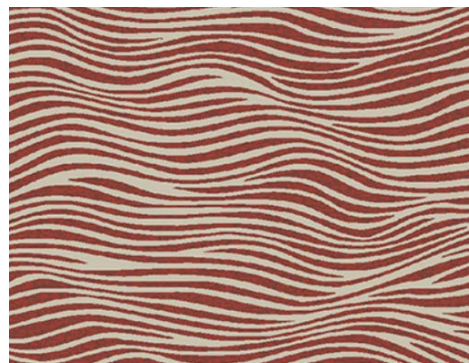

WALL TO WALL CARPETS - ST456



WALL TO WALL CARPETS - ST478



WALL TO WALL CARPETS - ST413

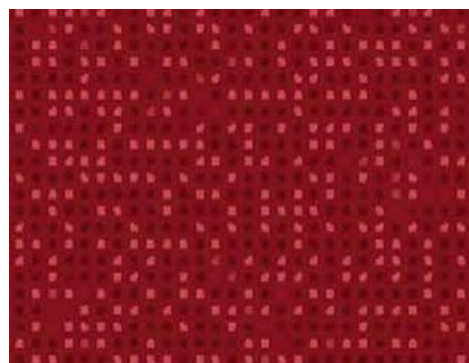

WALL TO WALL CARPETS - ST468



WALL TO WALL CARPETS - ST481

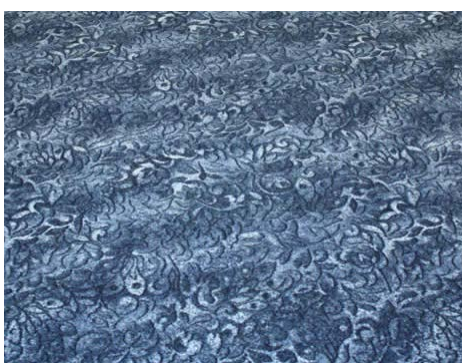

WALL TO WALL CARPETS - ST316



WALL TO WALL CARPETS - ST317



WALL TO WALL CARPETS - ST319



WALL TO WALL CARPETS - ST286

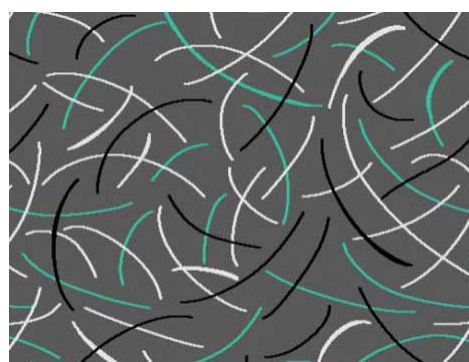

WALL TO WALL CARPETS - ST289

CARPET, PARQUET AND WALLPAPER



HOTEL TYPE WALLPAPERS - ST313



HOTEL TYPE WALLPAPERS - ST314



HOTEL TYPE WALLPAPERS - ST315



HOTEL TYPE WALLPAPERS - ST323



HOTEL TYPE WALLPAPERS - ST324



HOTEL TYPE WALLPAPERS - ST325



HOTEL TYPE WALLPAPERS - ST333

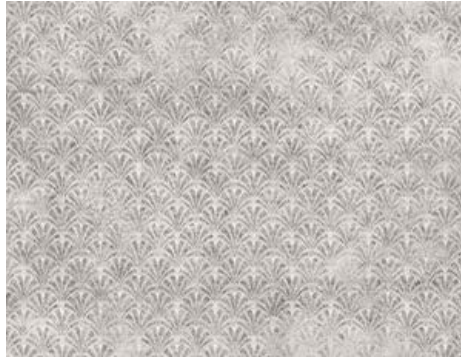

HOTEL TYPE WALLPAPERS - ST334



HOTEL TYPE WALLPAPERS - ST335



HOTEL TYPE WALLPAPERS - ST342



HOTEL TYPE WALLPAPERS - ST343



HOTEL TYPE WALLPAPERS - ST344

CARPET, PARQUET AND WALLPAPER



HOTEL TYPE WALLPAPERS - ST351



HOTEL TYPE WALLPAPERS - ST352



HOTEL TYPE WALLPAPERS - ST353



HOTEL TYPE WALLPAPERS - ST365



HOTEL TYPE WALLPAPERS - ST366

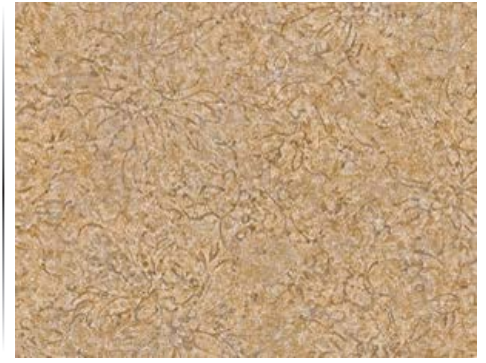

HOTEL TYPE WALLPAPERS - ST367



HOTEL TYPE WALLPAPERS - ST371



HOTEL TYPE WALLPAPERS - ST372



HOTEL TYPE WALLPAPERS - ST373



HOTEL TYPE WALLPAPERS - ST384

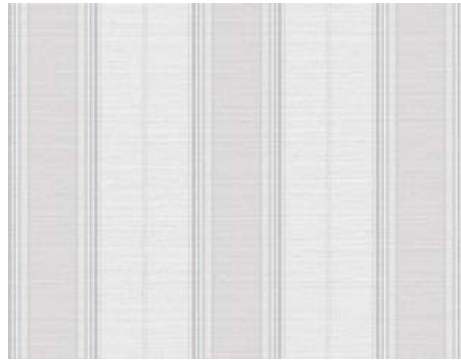

HOTEL TYPE WALLPAPERS - ST385



HOTEL TYPE WALLPAPERS - ST386

HAIR DRYER 1200 WATT



Technical Specification

Two Colour Option: Black / White
 1200W Power
 2 Level Speed Adjustment
 2 Level Heat Adjustment
 Easy Wall Mounting
 Fixation Screws and Screw Anchors
 87 m³/h Air Flow
 685 gr Product Weight
 Optional Feature
 110 / 220 V Shaver Socket

HAIR DRYER 1600 WATT



Technical Specification

Elegant design with chrome plated parts
 Two Colour Option: Black / White
 1600W Power
 2 Level Speed Adjustment
 3 Level Heat Adjustment
 Easy Wall Mounting
 Air Collector
 Fixation Screws and Screw Anchors
 87 m³/h Air Flow
 1.188 gr Product Weight (with shaver socket)
 Optional Feature
 110 / 220 V Shaver Socket

BATHROOM EQUIPMENT



7309

JET ENGINE ABS WHITE
AUTOMATIC HAND DRYER



7009 | HOTEL TYPE

1600 W
HOTEL TYPE HAIR DRYER



7008 | HOTEL TYPE

1600 W
HOTEL TYPE HAIR DRYER



7164 | HOTEL TYPE

OTELLO 1350 WATT
WIRED HAIR DRYER



7506 | AÇELYA

AÇELYA MIRROR 50X60



7635 | BRASS

BRASS MADE MOUNTED
TOOTH BRUSH HOLDER



7636 | BRASS

BRASS MADE MOUNTED
SOAP HOLDER

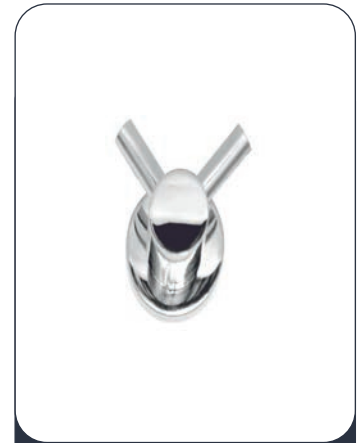

7642 | BRASS

BRASS MADE
BATHROBE HANGER



7643 | BRASS

BRASS MADE LONG
TOWEL HOLDER



7639 | BRASS

BRASS MADE WC PAPER
HOLDER



7638 | BRASS

BRASS MADE WC PAPER
HOLDER WITH LID



7637 | BRASS

BRASS MADE MOUNTED
SPARE PAPER HOLDER

BATHROOM EQUIPMENT



7800 | CHROME

380 ML ABS SHINY CHROME
FINISH LIQUID SOAP AND
SHAMPOO DISPENSER



7801 | SILVER

380 ML ABS MATT CHROME
FINISH LIQUID SOAP AND
SHAMPOO DISPENSER



7802 | WHITE

380 ML ABS WHITE
FINISH LIQUID SOAP AND
SHAMPOO DISPENSER



7803 | CHROME

380 ML ABS CHROME
FINISH DOUBLE LIQUID SOAP AND
SHAMPOO DISPENSER



2210 | CHROME

500 ML ABS SHINY CHROME
FINISH LIQUID SOAP AND
SHAMPOO DISPENSER



2211 | CHROME

500 ML ABS SHINY CHROME
FINISH LIQUID SOAP AND
SHAMPOO DISPENSER



2212 | CHROME

1000 ML ABS SHINY CHROME
FINISH LIQUID SOAP AND
SHAMPOO DISPENSER



2213 | CHROME

1000 ML ABS SHINY CHROME
FINISH LIQUID SOAP AND
SHAMPOO DISPENSER



7261

AUTOMATIC PAPER DISPENSER
PAPER SIZE: 21 cm
SIZE: 20x25x30
WITH ADAPTER



7934

AUTOMATIC PAPER DISPENSER
PAPER SIZE: 21 cm
SIZE: 20x25x30
WITH ADAPTER



7574

AUTOMATIC PAPER DISPENSER
PAPER SIZE: 21 cm
SIZE: 20x25x30
WITH ADAPTER



7514

1400W JET ENGINE HAND DRYER
220V-240V-/50HZ
POWER:1400W - WEIGHT:8,5 KG
SIZE:680X300X250 mm

BATHROOM EQUIPMENT



7687 | BRASS

BRASS MADE LONG TOWEL
HOLDER 50CM



7688 | BRASS

BRASS MADE WC PAPER
HOLDER 30 CM



7679 | BRASS

BRASS MADE BATHROBE
HANGER 2 HOOKS



7680 | BRASS

BRASS MADE BATHROBE
HANGER 2 HOOKS

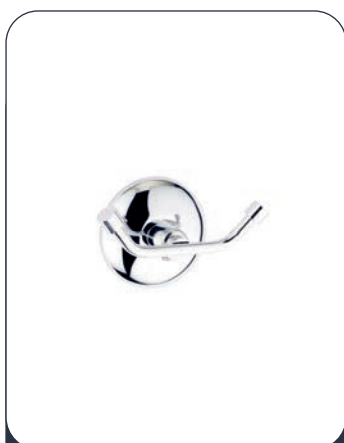

7320

BRASS BATHROBE HOLDER



7322

BRASS LONG TOWEL HOLDER

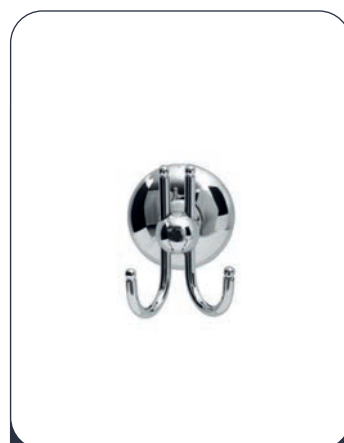

7323

BRASS BATHROBE HANGER
ANCHOR



8002

STAINLESS MADE
WC PAPER HOLDER



7074

BRASS MADE BATHROOM
CORNER SHELVES 18X18CM



7077

2 SHELVES
BRASS MADE BATHROOM
CORNER SHELVES 18X18CM



7080

1 SHELVES
BRASS MADE BATHROOM
CORNER SHELVES 18X18CM



8001

WC PAPER HOLDER WITH LID

BATHROOM EQUIPMENT

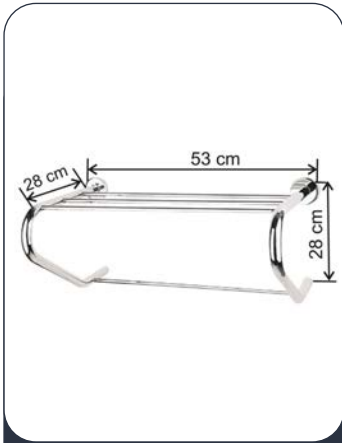

8032

TOWEL HOLDER WITH SHELVES

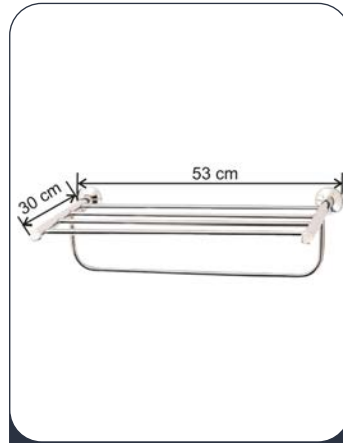

8033

TOWEL HOLDER WITH SHELVES



8034

TOWEL HOLDER WITH SHELVES AND U STAND



7148

STAINLESS STEEL DISABLED GRAB HANDLE 50CM



7291

WOODEN DISABLE SHOWER SEAT



7065 | CHROME

WC BRUSH PLASTIC BASE



2205 | CHROME

WC BRUSH WITH AUTOMATIC LID



7458 | CHROME

304 STAINLES STEEL WC BRUSH



7697 | BRASS

STAINLESS STEEL MOUNTED WC BRUSH



7698 | BRASS

GLASS MADE WC BRUSH

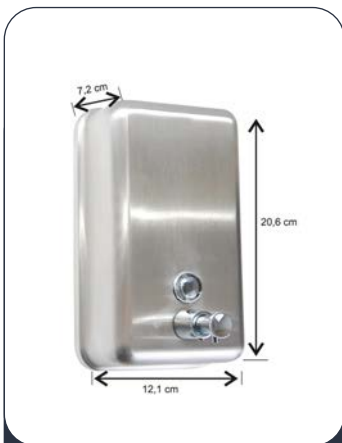

7254 | SHINY
7254 | MAT

CHROME FNISH NAPKIN DISPENSER
SIZE: 12,1X20,6X7,2 cm



7286 | SHINY
7461 | MAT

500 MT LIQUID SOAP
DISPENSER MOUNTED
SIZE: 15x9x5 cm

BATHROOM EQUIPMENT



7652-S

PAINTED WC BRUSH



7463 | 2 PUMP

2 PUMP 0,250 LIQUID
SOAP/SHAMPOO DISPENSER
CHROME FINISH/TRANSPARENT



7464 | 3 PUMP

3 PUMP 0,250 LIQUID
SOAP/SHAMPOO DISPENSER
CHROME FINISH/TRANSPARENT



7469 | 2 PUMP

2 PUMP 0,170 LIQUID
SOAP/SHAMPOO DISPENSER
CHROME FINISH/TRANSPARENT



7655-S

1 LT PAINTED LIQUID
SOAP DISPENSER



7654-S

1 LT PAINTED FOAM
DISPENSER



1012 - 70LT

70 LT PEDAL BIN



1070 - 95LT

95 LT PEDAL BIN



1096 - 35LT

MATT BLACK PEDAL BIN
WITH WATERPROOF
INTERIOR BUCKET



1097 - 45LT

MATT BLACK PEDAL BIN
WITH WATERPROOF
INTERIOR BUCKET

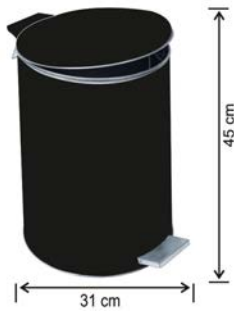

1098 - 35LT

MATT BLACK PEDAL BIN
WITH WATERPROOF
INTERIOR BUCKET

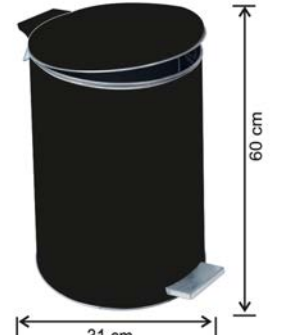

1099 - 45LT

MATT BLACK PEDAL BIN
WITH WATERPROOF
INTERIOR BUCKET

HOTEL FLOORING AND CLEANING PRODUCTS



7359

FLOOR CART CHROME FINISH



7350 | PAINTED

TWO BUCKET CLENGING CART WITH META PRESS AND PLASTIC BODY 90X45X80



7351 | CHROME

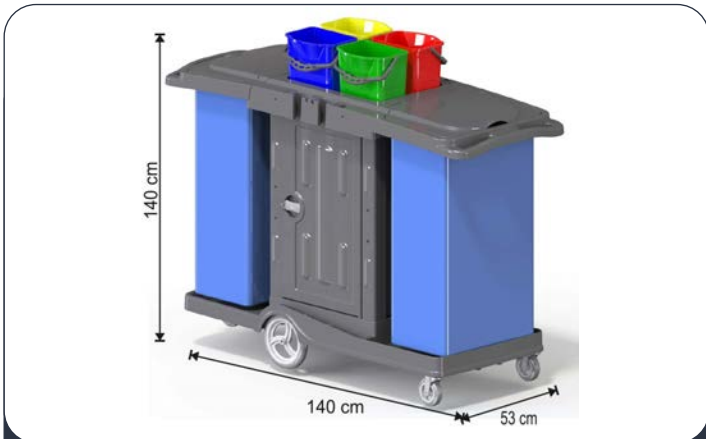

7358

FLOOR CART CHROME FINISH



7353

TWO BUCKET CLEANING CART WITH METAL PRESS AND BODY 90X45X80



7355

METAL PRESS



7356

RİNDO METAL PRESS



7354

PLASTIC PRESS

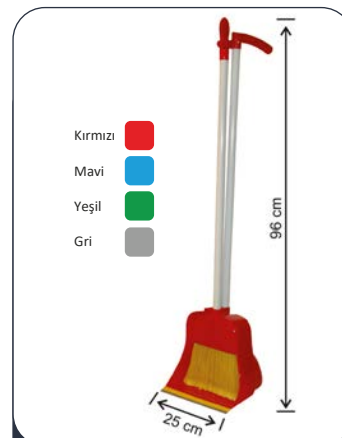

7580

LUX DUSTPAN WITH PLASTIC BRUSH

- Kırmızı ■
- Mavi ■
- Yeşil ■
- Gri ■



7357

WET FLOOR SIGN

HOTEL FLOORING AND CLEANING PRODUCTS



7731

CHROME FINISH FLOOR CART



7584

PAINTED 2 FLOOR LAUNDRY COLLECT CART

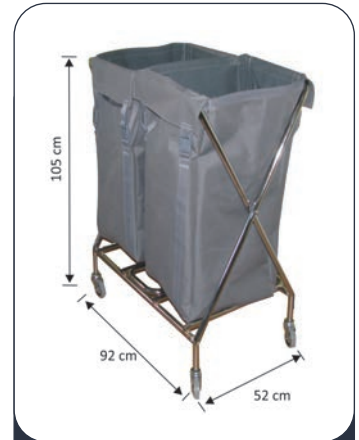

7585

CHROME 2 FLOOR LAUNDRY COLLECT CART



7489

LAUNDRY SERVICE CART



7496

LAUNDRY SERVICE CART



7490

LAUNDRY CART



7500 | CHROME

STAINLESS STEEL CARRY CART



7501 | PAINTED

PAINTED CARRY CART



7361

PAINTED GARBAGE CART



7556 | 80 LT

80 LT PLASTIC CONTAINER

HOTEL FLOORING AND CLEANING PRODUCTS

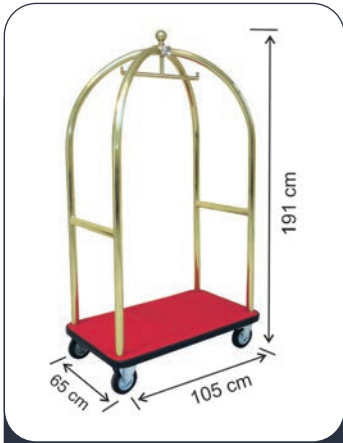

7453 | BRASS

LUGGAGE CARRY CART WITH BRASS HANGER

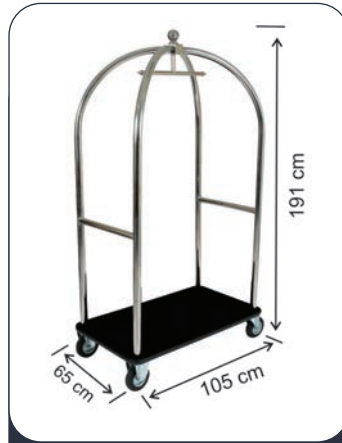

7454 | CHROME

LUGGAGE CARRY CART WITH STAINLESS HANGER

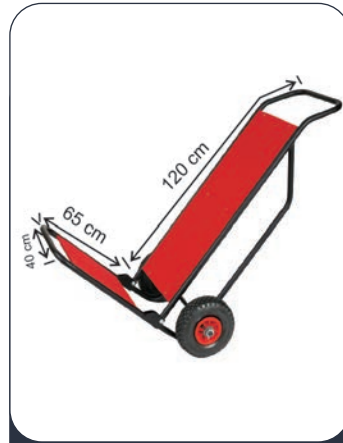

7455 | PAINTED

LUGGAGE CARRY CART WITH PAINTED HANGER



7455-P | BRASS

LUGGAGE CARRY CART WITH PAINTED HANGER

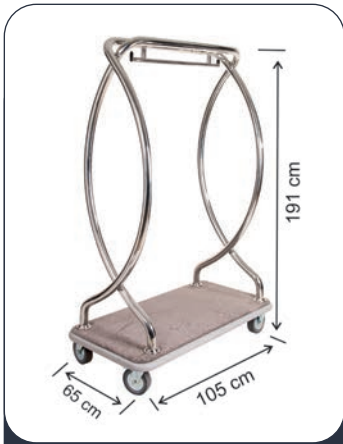

7502 | CHROME

STAINLESS STEEL LUGGAGE CARRYING CART



7512 | CHROME

STAINLESS STEEL LUGGAGE CARRYING CART WITH HANGER



7523

STAINLESS STEEL SHOE POLISHING MACHINE

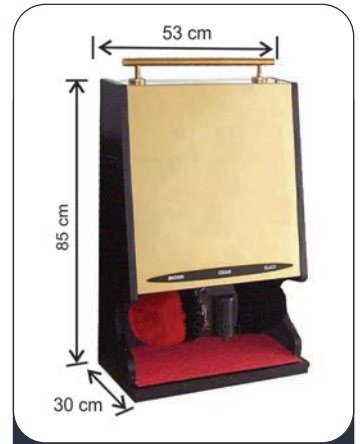

7521

SHOE POLISH MACHINE

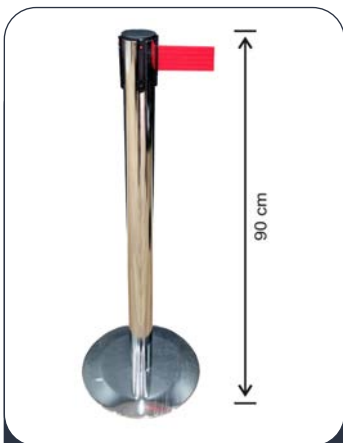

7520

BARRIER WITH SINGLE LINE



7570

PAINTED CROWN CONTROL BARRIER WITH SINGLE LINE



9107

CROWD CONTROL BARRIER CASSETTE 2,5 m



7601

BARRIER ROPE 2 m



HOTEL AMENITIES & SPA



HOTEL SOAPS



COSMETICS BOTTLE

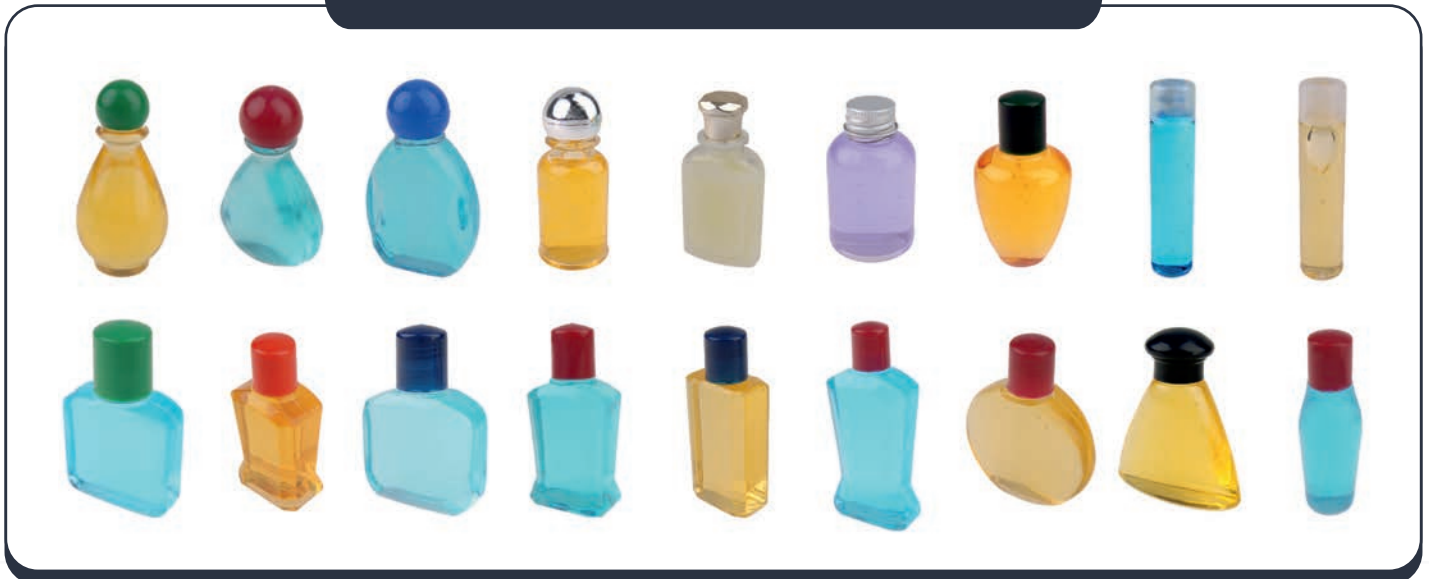

HOTEL SLIPPERS



HOTEL AMENITIES



SHOE POLISH BOX



MAKEUP COTTON BOX



RASP BOX



SEWING BOX

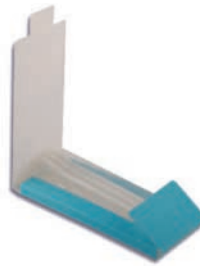

EAR COTTON BOX



EAR COTTON BOX WITH COVER



SHOWER CAP BOX



COMB BOX



SHAVING FOAM BOX



SHAVING SET BOX



RASP BOX



SEWING KIT BOX

HOTEL AMENITIES



HOTEL AMENITIES

