



KATALOG HOTELA

 **EYMEN**
TOURISM HOTEL TEXTILE D.O.O.





EY MEN

HOTEL TEXTILE EQUIPMENT
SINCE 1990



MONTENEGRO / OFFICE



+382 68 395579

Bulevar Veljka Vlahovica, II zgrada Fis Jase Invest, Poslovni Broj 8
Stari Aerodrom, Podgorica

info@eymen.me / www.eymen.me

TURKEY / ISTANBUL CENTER OFFICE



**SANTRAL HOTEL TEKSTİL EKİPMANLARI
İNŞAAT DEKORASYON LTD. ŞTİ.**

Kazlıçeşme Mah. Abay Cad. No:227
Zeytinburnu / İstanbul

(+90) 532 405 98 11

(+90) 533 096 34 44

www.santraloteltekstil.com

info@santraloteltekstil.com

TURKEY / ISTANBUL
SHOWROOM

 **EYMEN**
TOURISM HOTEL TEXTILE EQUIPMENT





HOTELSKI TEKSTILNI PROIZVODI	08-37
HOTELSKE ZAVESE I NAMJEŠTAJI	38-43
KREVETI I BAZE ZA KREKET	44-63
OPREMA ENTERIJERA PROSTORIJA	64-70
HOTELSKI RESTORAN STAKLENI PROIZVODI ·	71-73
TEPIH, PARKET I ZIDNI PAPIR	74-80
OPREMA ZA KUPATILO	81-86
HOTELSKI SPRAT I SREDSTVA ZA ČIŠĆENJE ·	87-89
BOUCLE PROIZVODI	90-96

NAŠE REFERENCE

- RAMADA HOTEL / PODGORICA
- IBEROSTAR HOTEL / BEČIĆI
- ADAMAR HOTEL
- ALBATROS HOTEL
- ALP INN HOTEL
- ALPİN HOTEL
- AMETHYST HOTEL
- AMIRAL PALACE HOTEL
- AMSTERDAM HOTEL
- ANTIS HOTEL
- ANTUSA DESIGN HOTEL
- ARDEN HOTEL
- ART NOUVEAU HOTEL
- ASIA CITY HOTEL
- ASPEN HOTEL
- AVCI PALACE HOTEL
- AVICANNE HOTEL
- BARKOD HOTEL
- BAVER HOTEL
- BEETHOVEN HOTEL
- BEKDAŞ HOTEL
- BENTLEY HOTEL
- BEYAZ SARAY HOTEL
- BIZANTIUM HOTEL
- BLACK BIRD HOTEL
- BLACK TULIP HOTEL
- BLUE RAYMOND HOTEL
- BRAKO HOTEL
- BRAM HOTEL
- BUDO HOTEL
- BUKE HOTEL
- BURÇKIN HOTEL
- BÜYÜK KULÜP
- BÜYÜK PARIS HOTEL
- BYZANTIUM HOTEL
- CASTEL FRANCO HOTEL & SUITE
- CELAL AĞA KONAĞI
- CITY CENTER HOTEL
- CORNER HOTEL
- ÇAĞYİĞİT HOTEL
- DALAN HOTEL
- DANIŞ HOTEL
- DARKHILL HOTEL
- DARKMEN HOTEL

NAŐE REFERENCE

- DARU SULTAN HOTEL
- DELTA HOTEL
- DOSSO DOSSİ HOTEL
- DURMAZ HOTEL
- DÜNDAR HOTEL
- EDİBE SULTAN HOTEL
- ELİTE WORLD HOTEL FLORYA
- ELİTE WORLD HOTEL HALKALI
- ELİTE WORLD HOTEL MARMARİS
- ELİTE WORLD HOTEL TAKSİM
- ELİTE WORLD HOTEL VAN
- EMİRHAN PLACE HOTEL
- EMOS HOTEL
- ENDİCAN HOTEL
- ESANS HOTEL
- ESCARDIN HOTEL
- EUROSTAR HOTEL
- FİDAN CITY HOTEL
- FLORA HOTEL
- FORS HOTEL
- FORSEVEN HOTEL
- GLORIOUS HOTEL
- GRAND ARAS HOTEL
- GRAND AŐIYAN HOTEL
- GRAND BEYAZIT HOTEL
- GRAND DURMAZ HOTEL
- GRAND GALATA HOTEL
- GRAND GÜLSOY HOTEL
- GRAND HALIÇ HOTEL
- GRAND HILARYUM HOTEL
- GRAND MADRID HOTEL
- GRAND MARCELLO HOTEL
- GRAND MIRA HOTEL
- GRAND ONS HOTEL
- GRAND SAĐCANLAR HOTEL
- GRAND ÜNAL HOTEL
- HALİFAKS HOTEL
- HAMIT BEY HOTEL
- HAVA KUVVETLERİ KOM.
- HILARIUM HOTEL
- HISTORY LOVELY HOTEL
- HİLTON TASHKENT
- ICON ISTANBUL HOTEL
- ISTANBUL MY DREAM HOTEL

NAŠE REFERENCE

- İLKBAL HOTEL
- İSTANBUL MIDPOINT HOTEL
- KİLİS OLEA HOTEL
- KUMRU HOTEL
- KYBELA HOTEL
- LADY DIANA HOTEL
- LE MARDEN HOTEL
- LEMİS HOTEL
- LIBERTY HOTEL
- LYON HOTEL
- MARBLE HOTEL
- MARCELLO HOTEL
- MARISTA HOTEL
- MARTINEZ HOTEL
- MATARACI KONAK
- MAYS ROYAL HOTEL
- MEVLANA OLD CITY
- MIDLE ASIA HOTEL
- MIDMAR HOTEL
- MIROLAYN HOTEL
- MISS HOTEL
- MOMENTO HOTEL
- MONACO HOTEL
- MOSAIC HOTEL
- MY HOUSE HOTEL
- NAUMPASA KONAĞI
- NENA HOTEL
- NEW STAR HOTEL
- NIPPON HOTEL
- NİDA HOTEL
- NO 12 HOTEL
- PASHA PLACE HOTEL
- PELL PALACE HOTEL
- PERA BOSPHOURUS HOTEL
- PERA ROSE HOTEL
- PERAHILL HOTEL
- PERALUNA HOTEL
- PİYA SPORT HOTEL
- POINT ANKARA HOTEL
- POINT BARBAROS HOTEL
- POINT HOTEL TAKSİM
- REAL STAR HOTEL
- REKOR HOTEL
- KENSINGTON HOTEL

NAŠE REFERENCE

- REPORT HOTEL
- ROSE GARDEN HOTEL
- RUMORS INN HOTEL
- SELENAY HOTEL
- SENATUS HOTEL
- SERES HOTEL
- SEVEN HILLS HOTEL
- SINEM HOTEL
- SKALION HOTEL
- SKY KAMER BUTIK HOTEL
- SKYSTAR HOTEL
- SORISSO HOTEL
- STYLE HOTEL ŞİŞLİ
- SULTAN SÜLEYMAN PALACE
- TAKSIM HILL HOTEL
- THE CENTRAL HOTEL
- THE CRATON HOTEL
- THE HALICH HOTEL
- THE TIME HOTEL
- TREND HOTEL
- ÜMİT HOTEL
- VATAN ASUR HOTEL
- VICTORY HOTEL
- WEIN GARD HOTEL
- WHITE MONARCH HOTEL
- WYNDHAM HOTEL
- VIA SPORT HOTEL
- YILSAM SULTANAHMET HOTEL
- YUVAM HOTEL



HOTELSKI TEKSTILNI PROIZVODI



ASKLEPIOS asklepios serija

peškir

100% Pamuk

Boja: braon/plava

16/1 hrpa prstenaste prede

20/2 mljevena prstenasta pređa

16/1 potka prstenasta pređa

Dvostruki Šav

Maksimalna sposobnost upijanja vode

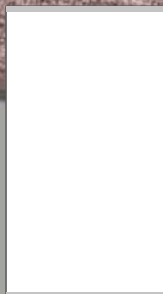

50x90 cm
200 gr./kom
450 gsm



70x140 cm
400 gr./kom
410 gsm



90x150 cm
600 gr./kom
450 gsm



TALIA talia serija

mop

100% Pamuk

Boja: Bijela

20/2 hrpa prstenaste pređe

20/2 mljevena prstenasta pređa

20/2 potka prstenasta pređa

Dvostruki Šav

Maksimalna sposobnost upijanja vode

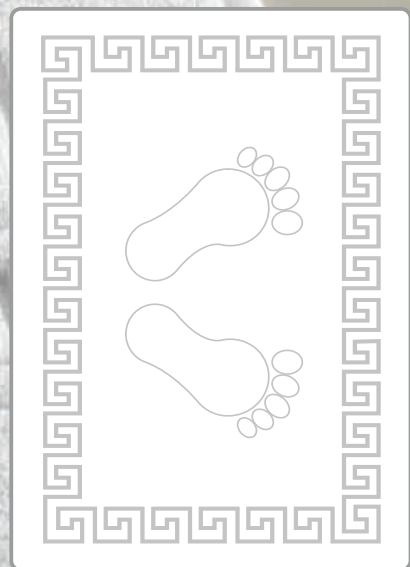

50x70 cm



IPERION iperion serija

peškir

100% Pamuk
Boja: Bijela
20/2 hrpa prstenaste pređe
20/2 mljevena prstenasta pređa
20/2 potka prstenasta pređa
Dvostruki Šav
Maksimalna sposobnost upijanja vode



50x90 cm
225 gr./kom
500 gsm



70x140 cm
450 gr./kom
460 gsm



90x150 cm
600 gr./kom
450 gsm

KRONOS kronos serija

peškir

100% Pamuk

Boja: Bijela

16/2 hrpa prstenaste pređe

20/2 mljevena prstenasta pređa

16/1 potka prstenasta pređa

Dvostruki Šav

Maksimalna sposobnost upijanja vode



50x90 cm
300 gr./kom
665 gsm



70x140 cm
600 gr./kom
610 gsm



90x150 cm
800 gr./kom
590 gsm

NEMESIS nemesis serija

bade mantil

100% Pamuk

Boja: Bijela

20/2 mljevena prstenasta pređa

16/1 potka prstenasta pređa

210 gsm

Maksimalna sposobnost upijanja vode

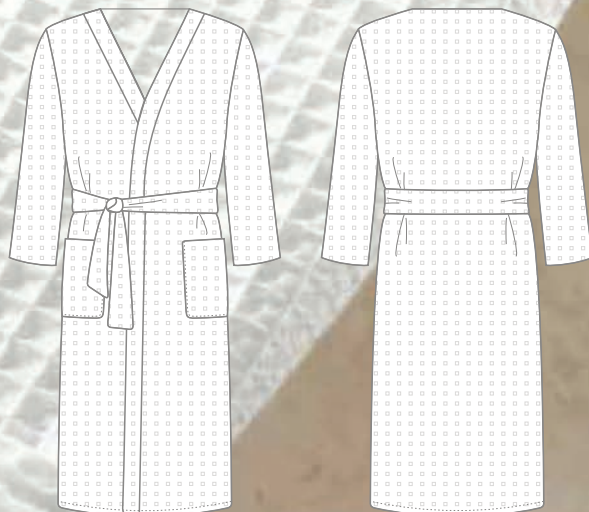

EROS eros serija

bade mantil

100% Pamuk

Boja: Bijela

16/1 hrpa prstenaste pređe

20/2 mljevena prstenasta pređa

16/1 potka prstenasta pređa

330 gsm-400 gsm

Maksimalna sposobnost upijanja vode



POSEIDON poseidon serija

bade mantil

100% Pamuk

Boja: Bijela

16/1 hrpa prstenaste prede

20/2 mljevena prstenasta pređa

16/1 potka prstenasta pređa

330 gsm-400 gsm

Maksimalna sposobnost upijanja vode



ORFE orfe serija

bade mantil

100% Pamuk

Boja: Bijela

16/1 hrpa prstenaste pređe

20/2 mljevena prstenasta pređa

16/1 potka prstenasta pređa

210 gsm

Maksimalna sposobnost upijanja vode



RISUS risus serija

100% Pamuk

Boja: Bijela

Savijanje: 40/1 Kompaktna Češljana Pamuk Tkanina

Potka: 40/1 Kompaktna Češljana Pamuk Tkanina

51 Savijanje x 32 Potka

125 gsm - 210 TC

0,5 cm Prugasta

4/1 Tkani

posteljina

160x220cm - 200x220cm - 220x240cm

Čaršaf

160x240cm - 200x240cm - 180x280cm - 240x280cm - 280x280cm

Jastučnica

50x70cm - 70x70cm - 50x70+5cm

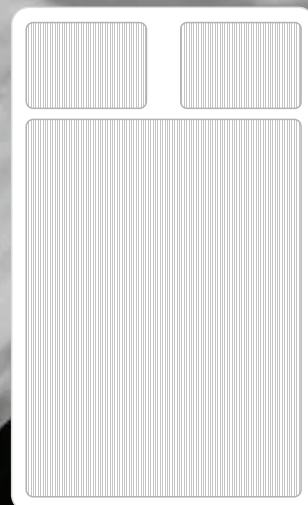

PAN pan serija

100% Pamuk
Boja: Bijela
Savijanje: 30/1 Pređa
Potka: 30/1 Pređa
33 Savijanje x 30 Potka
125 gsm - 160 TC
Ranforce
1/1 Tkani

posteljina

160x220cm - 200x220cm - 220x240cm

Čaršaf

160x240cm - 200x240cm - 180x280cm - 240x280cm - 280x280cm

Jastučnica

50x70cm - 70x70cm - 50x70+5cm

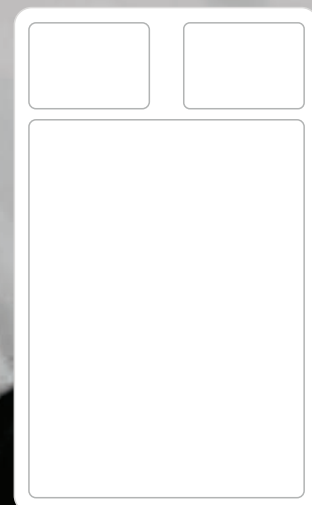

ERIS eris serija

100% Pamuk

Boja: Bijela

Savijanje: 40/1 Kompaktna Češljana Pamuk Tkanina

Potka: 40/1 Kompaktna Češljana Pamuk Tkanina

51 Savijanje x 32 Potka

125 gsm - 210 TC

Ravno Svilena

4/1 Tkani

posteljina

160x220cm - 200x220cm - 220x240cm

Čaršaf

160x240cm - 200x240cm - 180x280cm - 240x280cm - 280x280cm

Jastučnica

50x70cm - 70x70cm - 50x70+5cm

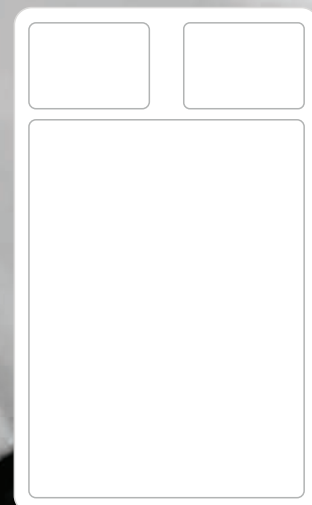

ZEUS zeus serija

100% Pamuk
Boja: Bijela
Savijanje: 40/1 Kompaktna Češljana Pamuk Tkanina
Potka: 40/1 Kompaktna Češljana Pamuk Tkanina
51 Savijanje x 32 Potka
125 gsm - 210 TC
1 cm Prugasta
4/1 Tkani

posteljina

160x220cm - 200x220cm - 220x240cm

Čaršaf

160x240cm - 200x240cm - 180x280cm - 240x280cm - 280x280cm

Jastučnica

50x70cm - 70x70cm - 50x70+5cm

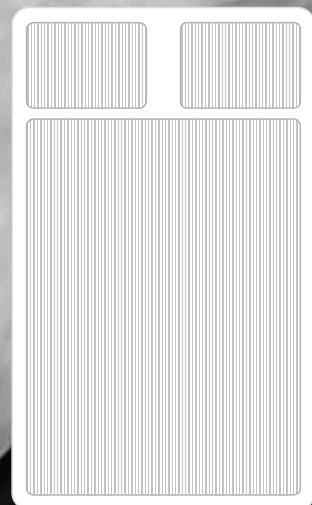

FEBRIS febris serija

100% Pamuk

Boja: Bijela

Savijanje: 40/1 Kompaktna Češljana Pamuk Tkanina

Potka: 40/1 Kompaktna Češljana Pamuk Tkanina

51 Savijanje x 32 Potka

125 gsm - 210 TC

Kvadratnog Uzoraka

4/1 Tkani

posteljina

160x220cm - 200x220cm - 220x240cm

Čaršaf

160x240cm - 200x240cm - 180x280cm - 240x280cm - 280x280cm

Jastučnica

50x70cm - 70x70cm - 50x70+5cm

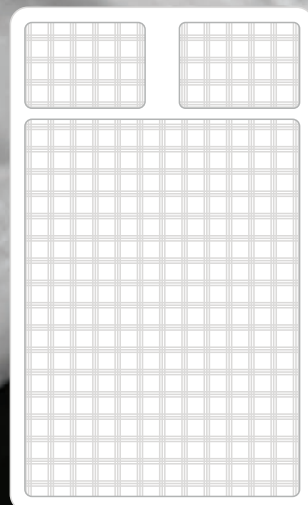

BUSSOLA
bussola serija

Vaše posebne narudžbe se izrađuju prema željenom kvalitetu i dimenzijama.



ANKYRA
ankyra serija

Vaše posebne narudžbe se izrađuju prema željenom kvalitetu i dimenzijama.



SCOPERTA
scoperta serija

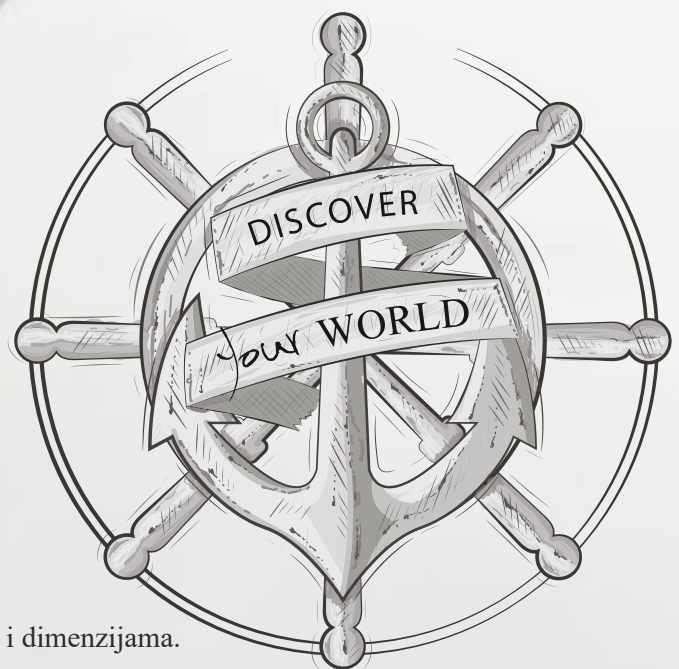

Vaše posebne narudžbe se izrađuju prema željenom kvalitetu i dimenzijama.

ANEMON anemon serija

100% Pamuk
Boja: Bijela
Savijanje: 20/2 Prstenasta Pređa
Potka: 10/2 Prstenasta Pređa
22 Savijanje x 15 Potka
300 gsm

prekrivač
160x230cm - 200x230cm

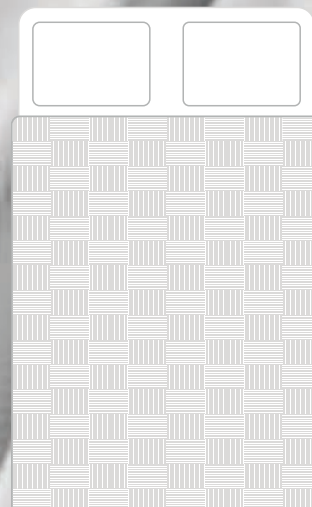

ARIEN arien serija

100% Pamuk
Boja: Bijela
Savijanje: 30/2 Prstenasta Pređa
Potka: 8/3 Prstenasta Pređa
42 Savijanje x 24 Potka
320 gsm

prekrivač
160x230cm - 200x230cm

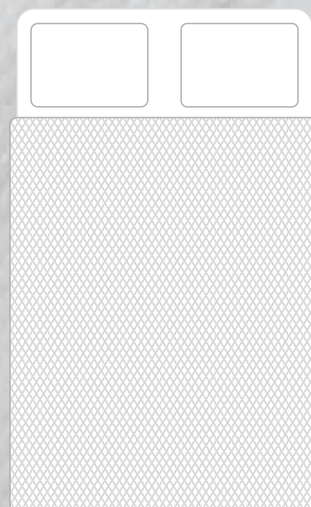

FOLO eolo serija

Ćebe

100% Flis

Boja: Različite Boje

250 gsm-300 gsm

Boja



1

2

3

4

5

6

7

8

9

10



160x220cm - 180x220cm
250 gr./m² - 300 gr./m²



BOREAS boreas serija

Ćebe

10% Pamuk 90% Akril

Boja



1

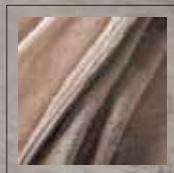

2



3

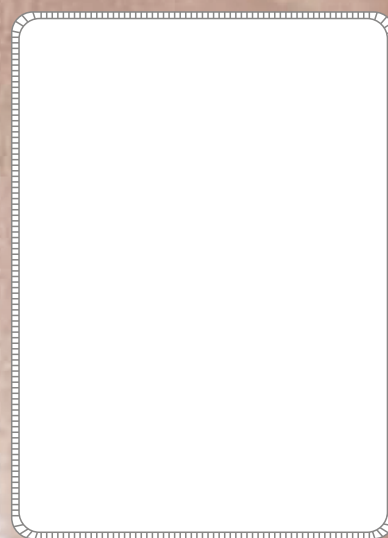

160x220cm - 180x220cm

TROYA troya serija

Jorgan

Tkanina 100% Pamuk
57 Žica – 145 TC
Punjen Silikon
300 gsm

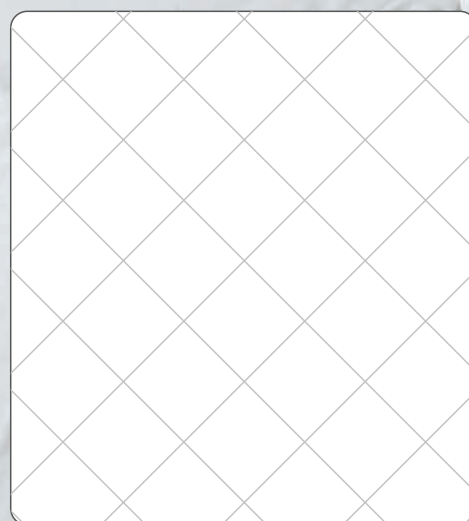

dimenzije

155x215cm - 195x215cm - 215x235cm

FLORA flora serija

Jorgan

Tkanina 100% Poliester
Mikrofiber 85gsm
Punjen Silikon
300 gsm

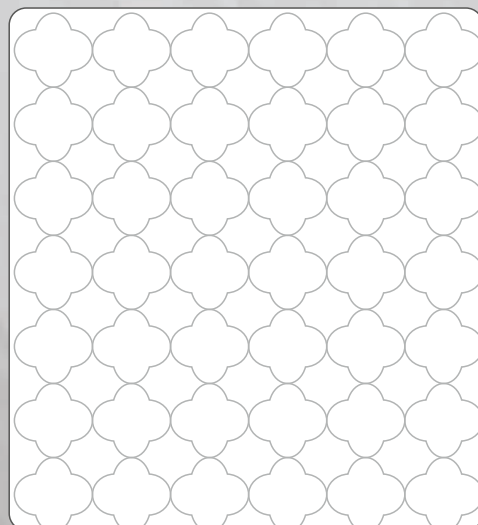

dimenzije

155x215cm - 195x215cm - 215x235cm

MENI JASTUKA

SDANDARD	VISOKO	UDOBNOST
Spoljašnja tkanina 100% pamuk, unutrašnja perla silikon 800 gr/komad	Spoljašnja tkanina 100% pamuk, unutrašnja perla silikon 950 gr/komad Visoki jastuk	Spoljašnja tkanina 100% pamuk, punjen nano gel silikon 1100 gr/komad Udobna upotreba

PRIRODNO	HIGIJENA	ORTOPEDIJA
Spoljašnja tkanina 100% pamuk, punjen 100% pamuk 1000 gr/komad Prirodni jastuk	100% pamuk, prošivena spoljna tkanina unutrašnja perla silikon 950 gr/komad Higijenski jastuk	Vanjska tkanina 100% bambus punjen viskozom 40x60+5cm Ortopedski jastuk

PODLOGA	HLADNO	UDOBNO
Vanjska tkanina 100% bambus punjen viskozom 36x60+12cm Jastuk sa podlogom	Cool tech pokrivanje punjen viskozom 40x60+5cm Rashladni jastuk	Spoljašnja tkanina 100% pamuk, punjen gušćom perjom 1000 gr/komad Udobno korištenje



MENI JASTUKA

SDANDARD



VISOKO



UDOBNOST



PRIRODNO



HIGIJENA



ORTOPEDIJA



PODLOGA

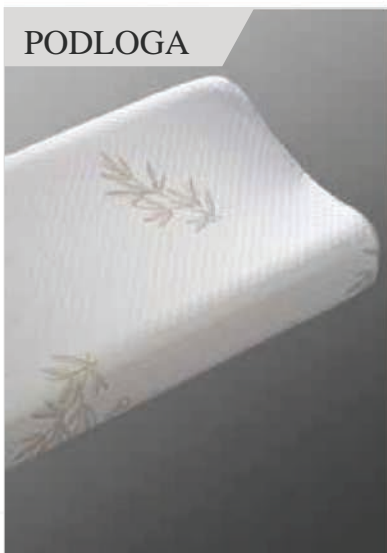

HLADNO



UDOBNO



CLEONE cleone serija

Podloga za spavanje

Dvostrana tkanina
Mikrovlakana i mekana
Punjen silikonom

90x190cm - 90x200cm - 100x200cm - 120x200cm - 140x200cm
160x200cm - 180x200cm - 200x200cm

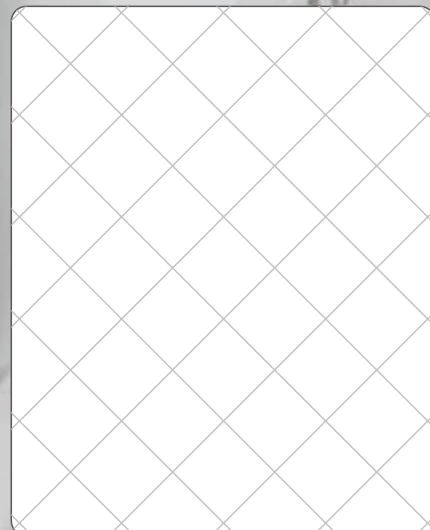

NELLIS nellis serija

Vodootporan dušek

Tkanina 80% Pamuk
20% Poliester
Poliuretanski premaz
145 gsm

90x190cm - 90x200cm - 100x200cm - 120x200cm - 140x200cm
160x200cm - 180x200cm - 200x200cm

OLEISIA oleisia serija

Prošiveni dušek

Tkanina 100% Pamuk
Punjen silikonom
90 gsm

90x190cm - 90x200cm - 100x200cm - 120x200cm - 140x200cm
160x200cm - 180x200cm - 200x200cm

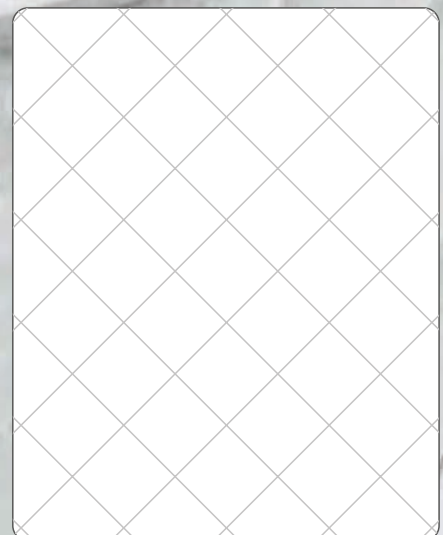

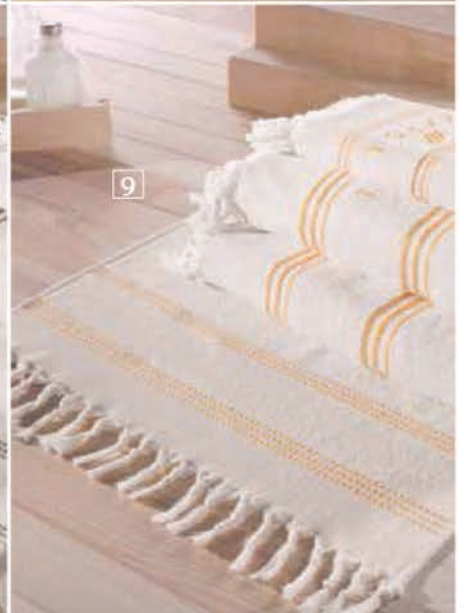



HOTELSKE ZAVESE I NAMJEŠTAJI



HOTELSKE ZAVESE I NAMJEŠTAJI



HOTELSE ZAVJESE - ST125

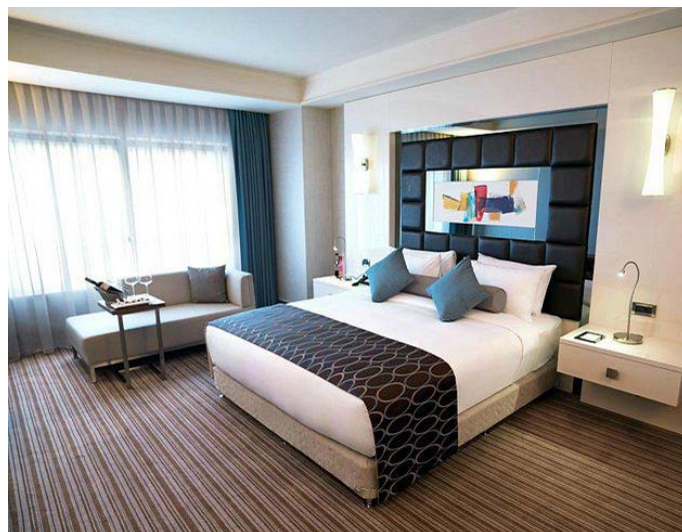

HOTELSE ZAVJESE - ST128



HOTELSE ZAVJESE - ST121



HOTELSE ZAVJESE - ST123



HOTELSE ZAVJESE - ST122



HOTELSE ZAVJESE - ST132



HOTELSE ZAVJESE - ST133

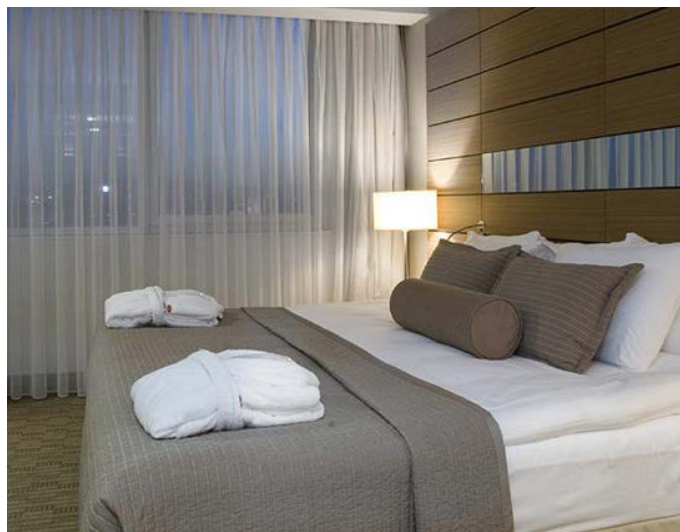

HOTELSE ZAVJESE - ST135



HOTELSE ZAVJESE - ST137



HOTELSE ZAVJESE - ST138



HOTELSE ZAVJESE - ST140



HOTELSE ZAVJESE - ST127



HOTELSE ZAVJESE - ST141



HOTELSE ZAVJESE - ST143



HOTELSE ZAVJESE - ST145



HOTELSKE ROLETNE ZEBRA - ST265



HOTELSKE ROLETNE ZEBRA - ST268



HOTELSKE ROLETNE ZEBRA - ST269



OMOTI ZA HOTELSKI KREKET



OMOTI ZA HOTELSKI KREKET



HOTELSKE ROLETNE - ST263



HOTELSKE ZAVESE OD TILA - ST025



HOTELSKE ZAVESE OD TILA - ST025



HOTELSKE ZAVESE OD TILA - ST029



KREVETI I BAZE ZA KREVET



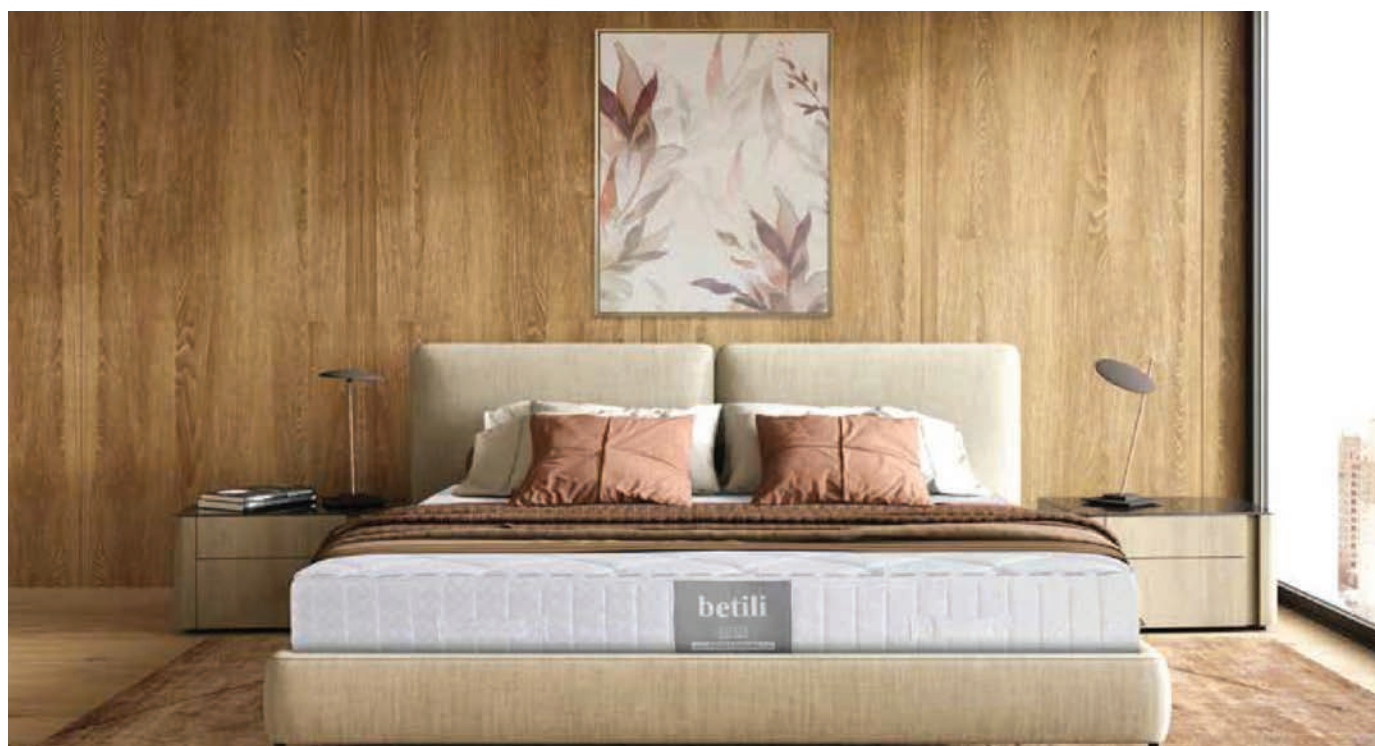

BETILI

INFORMACIJE O SADRŽAJU KREVETA

1. TKANINA VELIKIH KVADRATNIH UZORAKA
2. 150 gr/m² VLAKNO SILIKONSKOG PUNILA - 215 cm
3. 17 mm D22 ROL SUNDJER - 210 cm
4. 17 mm D22 ROL SUNDJER - 210 cm
5. 30 gr/m² BIJELA MEĐUPOSTAVNA TKANINA - 230 cm
6. 1600 gr CRNA PLOČA OD FILCA - 157x197 cm
7. 1600 gr CRNA PLOČA OD FILCA - 157x197 cm
8. MUTLISPRING OPRUŽNI SISTEM - 138x190x13,5 cm
9. 1600 gr CRNA PLOČA OD FILCA - 157x197 cm
10. 1600 gr CRNA PLOČA OD FILCA - 157x197 cm
11. D28 SUNDJERASTA PLOČA – SOFT - 10x14x187 cm

1. D28 SUNDJERASTA PLOČA – SOFT - 5x14x157 cm
2. TKANINA VELIKIH KVADRATNIH UZORAKA
3. 150 gr/m² VLAKNO SILIKONSKOG PUNILA - 215 cm
4. 17 mm D22 ROL SUNDJER - 210 cm
5. 17 mm D22 ROL SUNDJER - 210 cm
6. 30 gr/m² BIJELA MEĐUPOSTAVNA TKANINA - 230 cm
7. 17 mm D22 RROL SUNDJER - 210 cm
8. PLETENA TKANINA KVADRATNOG UZORAKA
9. 90 gr/m² SILIKON BEZ VLAKNA - 215 cm
10. 8 mm D15 AG ROL SUNDJER - 210 cm
11. 30 gr/m² BIJELA MEĐUPOSTAVNA TKANINA - 230 cm



**SREDNJE
TVRDOĆE**



26 cm



**MULTISPRING
OPRUŽNI
SISTEM**



**PLETENA
TKANINA**





RENAISSANCE

INFORMACIJE O SADRŽAJU KREVETA

1. QUEEN FR MATERIJAL - 225 cm
2. 150 gr/m² VLAKNO SILIKONSKOG PUNILA - 215 cm
3. 17 mm D22 ROL SUNDJER - 210 cm
4. 17 mm D26 BIJELI HYPER SUNDJER - 215 cm
5. 30 gr/m² BIJELA MEĐUPOSTAVNA TKANINA - 230 cm
6. D26 HYPER SUNDJERASTA PLOČA - 3x157x197 cm
7. 1000 gr CRNI FILLC PLOČA - 157x197 cm
8. 5 ZONE POCKET OPRUŽNI SISTEM - 147x185x13,5 cm
9. 1000 gr CRNI FILLC PLOČA - 157x197 cm
10. D28 PLOČA OD MEKOG SUNDJERA - 10x13,5x183 cm

1. D28 PLOČA OD MEKOG SUNDJERA - 7x13,5x157 cm
2. QUEEN FR MATERIJAL - 225 cm
3. 150 gr/m² PUNILO VLAKNO SA SILIKONOM - 215 cm
4. 17 mm D22 ROL SUNDJER - 210 cm
5. 17 mm D26 BIJELI HYPER SUNDJER - 215 cm
6. 30 gr/m² BIJELA MEĐUPOSTAVNA TKANINA - 230 cm
7. SVILENA TKANINA
8. 8 mm D15 AG ROL SUNDJER - 210 cm
9. 30 gr/m² BIJELA MEĐUPOSTAVNA TKANINA - 230 cm
- 10.



SREDNJE
TVRDOĆE



26 cm



5 ZONE POCKET
OPRUŽNI SISTEM



HYPER
SUNDJER





SWITZERLAND

INFORMACIJE O SADRŽAJU KREVETA

1. PJEŠČANI UZORAK JERSEY TKANINA - 230 cm
2. 150 gr/m² PUNILO VLAKNO SA SILIKONOM - 215 cm
3. 17 mm D26 BIJELI HYPER SUNDJER - 215 cm
4. 17 mm D22 ROL SUNDJER - 210 cm
5. 30 gr/m² BIJELA MEĐUPOSTAVNA TKANINA - 230 cm
6. D28 PLOČA OD TVRDOG SUNDJERA - 2x157x197 cm
7. 1000 gr CRNI FILLC PLOČA - 157x197 cm
8. 600 gr CRNI FILC – MEKI - 157x197 cm
9. 5 ZONE POCKET OPRUŽNI SISTEM - 147x178x13,5 cm
10. 600 gr CRNI FILC – MEKI - 157x197 cm
11. 1000 gr CRNI FILLC PLOČA 157x197 cm

1. D28 PLOČA OD MEKOG SUNDJERA - 10x13,5x183 cm
2. D28 PLOČA OD TVRDOG SUNDJERA - 2x157x197 cm
3. PJEŠČANI UZORAK JERSEY TKANINA - 230 cm
4. 150 gr/m² PUNILO VLAKNO SA SILIKONOM - 215 cm
5. 17 mm D26 HYPER ROL SUNDJER - 215 cm
6. 17 mm D22 ROL SUNDJER - 210 cm
7. 30 gr/m² BIJELA MEĐUPOSTAVNA TKANINA - 230 cm
8. 230 cm PJEŠČANI UZORAK JERSEY TKANINA
9. 90 gr/m² SILIKON BEZ VLAKNA - 215 cm
10. 8 mm D15 AG ROL SUNDJER - 210 cm
11. 30 gr/m² BIJELA MEĐUPOSTAVNA TKANINA - 230 cm



TVRDI



26 cm



ZONE POCKET
OPRUŽNI SISTEM



HYPER
ROL SUNDJER





QUASAR

INFORMACIJE O SADRŽAJU KREVETA

1. 280 gr/m² QUEEN FR MATERIJAL - 225 cm
2. 300 gr VLAKNO KOVRĐEVOG FILERA - 220 cm
3. 17 mm D26 BIJELA HYPER SUNDJER ROL - 215 cm
4. 30 gr/m² BIJELA MEĐUPOSTAVNA TKANINA - 230 cm
5. D22 SUNDJER PLOČA 2x157x197 cm
6. 200 gr BIJELI ROL FILC - 197 cm
7. D28 MEKI SUNDJER 11x19x157 cm
8. D28 MEKI SUNDJER 8x19x175 cm
9. POCKET OPRUŽNI SISTEM 1410x1820x200 mm

1. 200 gr BIJELI ROL FILC - 197 cm
2. 30 gr/m² BIJELA MEĐUPOSTAVNA TKANINA - 230 cm
3. D26 BIJELA HYPER SUNDJER ROL - 215 cm
4. 300 gr VLAKNO KOVRĐAVOG SILIKONSKOG PUNILA - 220 cm
5. 280 gr/m² QUEEN FR MATERIJAL - 225 cm
6. 280 gr/m² QUEEN FR MATERIJAL - 225 cm
7. 90 gr/m² PUNILO VLAKNO BEZ SILIKONA
8. 8 mm D15 AG ROL SUNDJER - 210x0,8 cm
9. 30 gr/m² BIJELA MEĐUPOSTAVNA TKANINA - 220 cm



SREDNJE
TVRDOĆE



31 cm



ZONE POCKET
OPRUŽNI SISTEM



HYPER
SUNDJER





PLATINIUM

INFORMACIJE O SADRŽAJU KREVETA

1. PJEŠČANI UZORAK JERSEY TKANINA - 230 cm
2. 150 gr/m² PUNILO VLAKNO SA SILIKONOM - 215 cm
3. 17 mm D26 BIJELA HYPER SUNDJER ROL - 215 cm
4. 17 mm D22 ROL SUNDJER - 210 cm
5. 17 mm D26 BIJELA HYPER SUNDJER ROL - 215 cm
6. 30 gr/m² BIJELA MEĐUPOSTAVNA TKANINA - 230 cm
7. 1600 gr GR CRNA PLOČA OD FILCA - 157x197 cm
8. 1600 gr GR CRNA PLOČA OD FILCA - 157x197 cm
9. MUTLISPRING OPRUŽNI SISTEM - 138x190x13,5 cm
10. 1600 gr GR CRNA PLOČA OD FILCA - 157x197 cm
11. 1600 gr GR CRNA PLOČA OD FILCA - 157x197 cm

1. D28 SUNDJERASTA PLOČA – SOFT - 10x14x187 cm
2. D28 SUNDJERASTA PLOČA – SOFT - 5x14x157 cm
3. PJEŠČANI UZORAK JERSEY TKANINA - 230 cm
4. 150 gr/m² VLAKNO SILIKONSKOG PUNILA - 215 cm
5. 17 mm D22 ROL SUNDJER- 210 cm
6. 17 mm D26 BIJELA HYPER SUNDJER ROL - 215 cm
7. 30 gr/m² BIJELA MEĐUPOSTAVNA TKANINA - 230 cm
8. PJEŠČANI UZORAK JERSEY TKANINA - 230 cm
9. 90 gr/m² SILIKON BEZ VLAKNA - 215 cm
10. 8 mm D15 AG ROL SUNDJER - 210 cm
11. 30 gr/m² BIJELA MEĐUPOSTAVNA TKANINA - 230 cm



TVRDI



30 cm



MUTLISPRING
OPRUŽNI SISTEM



HYPER
SUNDJER





CALIFORNIA

INFORMACIJE O SADRŽAJU KREVETA

1. 280 gr/m² QUEEN TKANINA - 225 cm
2. 150 gr/m² PUNILO VLAKNO SA SILIKONOM - 215 cm
3. 17 mm D26 BIJELA HYPER SUNDJER ROL - 215 cm
4. 17 mm D26 BIJELA HYPER SUNDJER ROL - 215 cm
5. 17 mm D26 BIJELA HYPER SUNDJER ROL - 215 cm
6. 30 gr/m² BIJELA MEĐUPOSTAVNA TKANINA - 230 cm
7. D22 SUNDJER PLOČA - 2x157x197 cm
8. 600 gr MEKO - CRNI PLOČAR - 157x197 cm
9. MIRACOIL OPRUŽNI SISTEM - 138x185x14,5 cm
10. D28 MEKA SUNDJERASTA PLOČA - 10x14,5x186 cm
11. D28 MEKA SUNDJERASTA PLOČA - 5,5x14,5x157 cm

1. 600 gr MEKO - CRNI PLOČAR - 157x197 cm
2. D22 SUNDJER PLOČA - 2x157x197 cm
3. 280 gr/m² QUEEN TKANINA - 225 cm
4. 150 gr/m² PUNILO VLAKNO SA SILIKONOM - 215 cm
5. 17 mm D26 BIJELA HYPER SUNDJER ROL - 215 cm
6. 17 mm D26 BIJELA HYPER SUNDJER ROL - 215 cm
7. 17 mm D26 BIJELA HYPER SUNDJER ROL - 215 cm
8. 30 gr/m² BIJELA MEĐUPOSTAVNA TKANINA - 230 cm
9. SATURN OPTIČKA TKANINA
10. 8 mm D15 AG ROL SUNDJER - 210 cm
11. 30 gr/m² BIJELA MEĐUPOSTAVNA TKANINA - 230 cm



SREDNJE
TVRDOĆE



32 cm



MIRACOIL
OPRUŽNI SISTEM



HYPER
SUNDJER





VEGAS DREAM

INFORMACIJE O SADRŽAJU KREVETA

1. TKANINA SA SREBRNIM TALASOM - 235 cm
2. 300 gr/m² SILIKONSKO VLAKNO KOVRĐEVOG FILERA
3. 300 gr/m² SILIKONSKO VLAKNO KOVRĐEVOG FILERA
4. 17 mm D26 BIJELA HYPER SUNDJER ROL - 215 cm
5. 30 gr/m² BIJELA MEĐUPOSTAVNA TKANINA - 230 cm
6. VISCO GEL SUNDJER PLOČA - 2x157x197 cm
7. VISCO SUNDJER PLOČA - 5x157x197 cm
8. PLOČA OD TVRDOG SUNDJERA - 2,5x157x197 cm
9. D18 SUNDJER PLOČA - 1,5x157x197 cm
10. 200 gr BIJELI ROL FILC - 197 cm

1. POCKET OPRUŽNI SISTEM - 141x182x20 cm
2. D28 MEKI SUNDJER - 11x19x157 cm
3. D28 MEKI SUNDJER - 8x19x175 cm
4. 200 gr BIJELI ROL FILC - 197 cm
5. 5 mm D15 AG ROL SUNDJER - 210 cm
6. 15 gr/m² BIJELA MEĐUPOSTAVNA TKANINA - 230 cm
7. BIJELA SVILENA TKANINA
8. 90 gr/m² PUNILO VLAKNO
9. 8 mm D15 AG ROL SUNDJER - 210 cm
10. 30 gr/m² BIJELA MEĐUPOSTAVNA TKANINA - 230 cm



**SREDNJE
TVRDOĆE**



35 cm



**POCKET OP
RUŽNI
SISTEM**



**HYPER
SUNDJER**



**VISCO
GEL**



**VIOL
SUNDJER**





CEREMONIE

INFORMACIJE O SADRŽAJU KREVETA

1. PERU PÍCCHU 4X4 POCKET UZORAK TKANINA
2. 250 gr/m² VLAKNO SILIKONSKOG PUNILA
3. 300 gr/m² VLAKNO SILIKONSKOG PUNILA
4. 17 mm D26 BIJELA HYPER SUNDJER ROL - 215 cm
5. 17 mm D22 ROL SUNDJER - 215 cm
6. 30 gr/m² BIJELA MEĐUPOSTAVNA TKANINA - 230 cm
7. 17 mm D26 BIJELA HYPER SUNDJER ROL - 215 cm
8. 24 mm D28 MEKI SUNDJER ROL - 215 cm
9. 11000 gr/m² CRNI FILLC PLOČA
10. MIRA-COIL OPRUŽNI SISTEM - 2,4x13,5 cm - 185 kom/m

1. 1000 gr/m² CRNI FILLC PLOČA
2. 30 mm D22 ROL SUNDJER - 215 cm
3. D26 TVRDI OKVIR SUNDJER
4. OBIČNA BIJELA TKANINA
5. 5 mm D15 AG ROL SUNDJER - 210 cm
6. 15 gr/m² BIJELA MEĐUPOSTAVNA TKANINA - 230 cm
7. VANILIJA BIJELA TKANINA
8. 90 gr/m² VLAKNO SILIKONSKOG PUNILA
9. 8 mm D15 AG ROL SUNDJER - 210 cm
10. 30 gr/m² BIJELA MEĐUPOSTAVNA TKANINA - 230 cm



**SREDNJE
TVRDOĆE**



30 cm



**MIRA-COIL
OPRUŽNI
SISTEM**



**HYPER
SUNDJER**



**PODLOGA ZA
POMOĆNI LEŽAJ**





ANTARES

INFORMACIJE O SADRŽAJU KREVETA

1. %100 PES TKANINA - 220 cm
2. D50 VISCO GEL SUNDJER - 5x100x200 cm
3. D35 HR TVRDI SUNDJER - 15x100x200 cm

1. D22 SUNDJER - 5x100x200 cm
2. 248 gr/m² TKANINA ZA KREVET PROTIV KLIZANJA - 213 cm
3. %100 PES TKANINA - 220 cm



SREDNJE
TVRDOĆE



26 cm



VISCO
GEL
SUNDJER





SMYRNA

INFORMACIJE O SADRŽAJU KREVETA

1. 280 gr/m² RAMA TKANINA ZA KREVET - 235 cm
2. D35 FLEXI PROFIL SUNDJER 2,5x177x197cm
3. D35 HR MEKI SUNDJER 5x177x197cm
4. 1000 gr/m² CRNA PLOČA OD FILCA
5. POCKET OPRUŽNI SISTEM - 87x197x15 cm
6. D26 TVRDI SUNDJER - 8x15x183 cm
7. D26 TVRDI SUNDJER - 7x15x177 cm
8. 1000 gr/m² CRNA PLOČA OD FILCA - 177x197 cm

1. D22 SUNDJER PLOČA - 2x177x197 cm
2. PLETENA TKANINA KVADRATNOG - 220 cm
3. 8 mm D15 AG ROL SUNDJER - 210 cm
4. 30 gr/m² BIJELA MEĐUPOSTAVNA TKANINA - 230 cm
5. 280 gr/m² RAMA TKANINA ZA KREVET - 235 cm
6. 150 gr/m² VLAKNO SILIKONSKOG PUNILA - 235 cm
7. 5 mm D15 AG ROL SUNDJER - 210 cm
8. 15 gr/m² BIJELA MEĐUPOSTAVNA TKANINA - 230 cm



SREDNJE
TVRDOĆE



30 cm



POCKET
OPRUŽNI
SISTEM



PODLOGA ZA
POMOĆNI LEŽAJ





ANATOLIA

INFORMACIJE O SADRŽAJU KREVETA

1. 280 gr/m² QUEEN TKANINA - 225 cm
2. 150 gr/m² VLAKNO SILIKONSKOG PUNILA
3. 17 mm D26 BIJELA HYPER SUNDJER ROL - 215 cm
4. 17 mm D26 BIJELA HYPER SUNDJER ROL - 215 cm
5. 30 gr/m² BIJELA MEĐUPOSTAVNA TKANINA - 230 cm
6. D50 VISCO SUNDJER - 3,3x157x197 cm
7. 200 gr/m² BIJELI ROL FILC 197 cm
8. MIRA-COIL OPRUŽNI SISTEM - 77x185x14,5
9. D26 TVRDI SUNDJERASTA PLOČA - 10x14,5x186 cm
10. D26 TVRDI SUNDJERASTA PLOČA - 10x14,5x186 cm

1. 200 gr/m² BIJELI ROL FILC 197 cm
2. LATEKS SUNDJER - 14x120x200 cm
3. 150 gr/m² VLAKNO SILIKONSKOG PUNILA
4. 17 mm D26 BIJELA HYPER SUNDJER ROL - 215 cm
5. 17 mm D26 BIJELA HYPER SUNDJER ROL - 215 cm
6. 15 gr/m² BIJELA MEĐUPOSTAVNA TKANINA - 230 cm
7. 280 gr/m² QUEEN TKANINA - 225 cm
8. 90 gr/m² PUNILNO VLAKNO - 215 cm
9. 8 mm D15 AG ROL SUNDJER - 210 cm
10. 30 gr/m² BIJELA MEĐUPOSTAVNA TKANINA - 230 cm



SREDNJE
TVRDOĆE



32 cm



MIRA-COIL
OPRUŽNI
SISTEM



HYPER
SUNDJER



VISCO
SUNDJER



LATEKS
SUNDJER



ZAMAŠNJAK PODLOGA ZA KREVET

DVOKRETNÁ UDOBNOST NA JEDNAČKOM KREVETU!





KREKET NA SKLOP



PRAKTIČNO I UDOBNO

LAKO PRENOSIVI DIZAJN KOJI SE MOŽE OTVORITI ČAK I JEDNOM RUKOM

KREKET NA PREKLOP – DIMENZIJA

1. 80x190 cm

2. 90x200 cm

3. 100x200 cm

OPRUŽNA BAZA KREVETA

FLEKSIBILNOST, UDOBNOST I PERFORMANSE...



SPAJANJE METALNIH APARATA

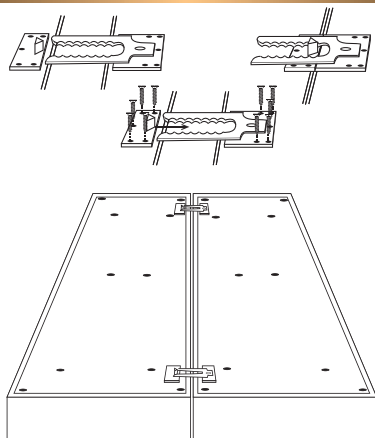

VISINA BAZE KREVETA
DIMENZIJA (cm)
20 cm

DIMENZIJA (cm)	DIMENZIJA (cm)
80x200 cm	140x200 cm
90x200 cm	150x200 cm
100x200 cm	150x200 cm (2P)
110x200 cm	160x200 cm
120x200 cm	160x200 cm (2P)
130x190 cm	180x200 cm
140x190 cm (2P)	180x200 cm (2P)
140x190 cm	200x200 cm (2P)



VERTIKALNA BAZA

POBEDA SA TERENA...

DIMENZIJA (cm)
90x190 cm
90x200 cm

POLY BAZA KREVETA



OSJETITE MOĆ I UDOBNOST!



SPAJANJE KLIP APARATA

Možete jednostavno spojiti dvije YATSAN poly baze kreveta za jednu osobu, jedna na drugu s gornje strane pomoću posebne spojne kopče, bez korištenja vijaka ili sličnog materijala za spajanje.

VISINA BAZE KREVETA DIMENZIJA (cm)	DIMENZIJA (cm)	DIMENZIJA (cm)
14 cm	80x200 cm	140x200 cm
20 cm	90x200 cm	150x200 cm
	100x200 cm	150x200 cm (2P)
	110x200 cm	160x200 cm
	120x200 cm	160x200 cm (2P)
	130x190 cm	180x200 cm
	140x190 cm (2P)	180x200 cm (2P)
	140x190 cm	200x200 cm (2P)

NEW ELITE BAZA KREVETA



ELITNO, ESTETSKO I PRAKTIČNO!



SPAJANJE KLIP APARATA

Možete jednostavno spojiti dvije YATSAN poly baze kreveta za jednu osobu, jedna na drugu s gornje strane pomoću posebne spojne kopče, bez korištenja vijaka ili sličnog materijala za spajanje.

VISINA BAZE KREVETA DIMENZIJA (cm)	DIMENZIJA (cm)	DIMENZIJA (cm)
14 cm	80x200 cm	140x200 cm
20 cm	90x200 cm	150x200 cm
	100x200 cm	150x200 cm (2P)
	110x200 cm	160x200 cm
	120x200 cm	160x200 cm (2P)
	130x190 cm	180x200 cm
	140x190 cm (2P)	180x200 cm (2P)
	140x190 cm	200x200 cm (2P)

STAR KAUČ NA RAZVLAČENJE

SKROMAN U SVOJOJ JEDNOSTAVNOSTI, AMBICIOZAN U SVOM DIZAJNU...



KALINA UGAONI SET

ELITNO, ESTETSKO I PRAKTIČNO!





OPREMA ENTERIJERA PROSTORIJA



SM 40 BLOK

SM 40 STAKLO



Model	SM 40 Blok	SM 40 Staklo
Neto zapremina Lt.	36	40
Vanjske dimenzije (VxŠxD) mm.	557X408X454	557X408X454
Potrošnja energije kWh/dan	1,20	1,40
Neto težina kg.	11,11	11,11
Nivo buke	0 dB	0 dB
Karakteristike		
Sistem hlađenja	Apsorpcija	Apsorpcija
LED lampa	Nema (opciono)	Nema (opciono)
Automatsko odmrzavanje	Nema	Nema
Promjena smjera vrata	Standart	Standart
Kontrola termostata	Mehanički	Mehanički
Držac za flašu od 1,5 l	Dostupno	Dostupno
Polica	Bijela polica	Bijela polica



SM 40 ECO

Upotreba C-pentana (100% ekološki prihvatljiv)
 Apsorpcijski sistem hlađenja
 LED rasvjeta (nema)
 Automatsko odmrzavanje (opciono)
 Reverzibilna vrata (standardna)
 Vrata specijalnog dizajna (standardna)
 Kontrola termostata (mehanička)
 Držac za flašu od 1,5 l (dostupno)
 Polica (bijela plastična)



Tehničke karakteristike

Bruto zapremina (lt)	38 LT - 44 LT
Neto zapremina (lt)	33 LT - 40 LT
Veličina proizvoda (V x Š x D) mm.	566x441x457
Veličina pakovanja (V x Š x D) mm	614x464x494
Tip particije	Podrum
Sistem hlađenja	Apsorpcija
Potrošnja energije (kWh/god.)	230 - 430
Indeks energetske efikasnosti	291
Klimatska klasa	N (16° - 32°)
Temperatura skladištenja proizvoda C°	8-14
Bruto težina	13,30 kg - 17,20 kg
Neto težina	12,00 kg - 15,90 kg
Snaga	60 W - 75 W
Izvor napajanja	220 V or 240 V - 110 V or 230 V / 50-60 Hz
Kapacitet utovara kontejnera 20' / 40' / 40'hc	165-360-480



SM 27 ECO

Upotreba C-pentana (100% ekološki prihvatljiv)
 Apsorpcijski sistem hlađenja
 Led rasvjeta (nema)
 Automatsko odmrzavanje (opciono)
 Reverzibilna vrata (standardna)
 Vrata specijalnog dizajna (standardna)
 Kontrola termostata (mehanička)
 Držać za flašu od 1,5 l (dostupno)
 Polica (bijela plastična)

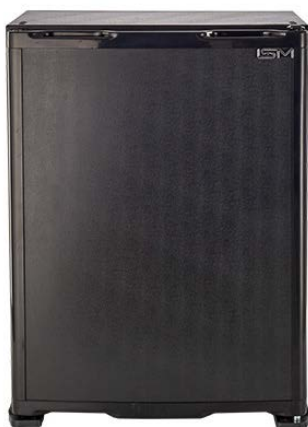

Tehničke karakteristike

Bruto zapremina (lt)	24 LT -28 LT
Neto zapremina (lt)	21 LT- 24 LT
Veličina proizvoda (V x Š x D) mm.	512x390x423
Veličina pakovanja (V x Š x D) mm	559x432x464
Tip particije	Podrum
Sistem hlađenja	Apsorpcija
Potrošnja energije (kWh/god.)	226 - 526
Indeks energetske efikasnosti	290-674
Klimatska klasa	N (16° - 32°)
Temperatura skladištenja proizvoda C°	8-12
Bruto težina	11,45 kg -14,90 kg
Neto težina	10,15 kg - 13,60 kg
Snaga	60 W - 75 W
Izvor napajanja	220 V or 240 V / 50-60 Hz
Kapacitet utovara kontejnera 20' / 40' / 40'hc	260-520-520

SM 30 ECO

Upotreba C-pentana (100% ekološki prihvatljiv)
 Apsorpcijski sistem hlađenja
 Led rasvjeta (nema)
 Automatsko odmrzavanje (opciono)
 Vrata specijalnog dizajna (standardna)
 Reverzibilna vrata (standardna)
 Kontrola termostata (mehanička)
 Držać za flašu od 1,5 l (nema)
 Polica (bijela plastična)



Tehničke karakteristike

Bruto zapremina (lt)	30 LT
Neto zapremina (lt)	26 LT
Veličina proizvoda (V x Š x D) mm.	512x419x423
Veličina pakovanja (V x Š x D) mm	559x442x464
Tip particije	Podrum
Sistem hlađenja	Apsorpcija
Potrošnja energije (kWh/god.)	226 - 372
Indeks energetske efikasnosti	288
Klimatska klasa	N (16° - 32°)
Temperatura skladištenja proizvoda C°	8-14
Bruto težina	11,80 kg - 15,50 kg
Neto težina	10,50 kg - 14,20 kg
Snaga	60 W
Izvor napajanja	220 V or 240 V - 110 V - 230 V / 50-60 Hz
Kapacitet utovara kontejnera 20' / 40' / 40'hc	260-520-520



TELEVIZOR HOTELSKOG TIPA

32 inča



TELEVIZOR HOTELSKOG TIPA

40 inča

HOTELSKI SOBA SEF

MODEL: S2-2C STANDARD

MODEL: T2-2C LAPTOP VELIČINA



Tehničke karakteristike

Boja: Slonova kost/Crna

Mogućnost najma kompjutera

Vanjske dimenzije VxŠxD: 220x400x420mm

Debljina lima: 1,8 mm

Debljina lima vrata: 2,8 mm

Motorizovani mehanizam za zaključavanje

6-cifreni digitalni displej

Definiranje korisničke lozinke od 4-6 cifara

Glavna lozinka od 6 cifara

Glavni ključ (za otvaranje sefa sa ključem u slučaju nužde)

Pojavljivanje/nepojavljivanje unešene lozinke na ekranu

(tokom biranja) opcija

Automatsko zaključavanje unosom pogrešne lozinke 4 puta za redom

Zadnjih 100 transakcija može se obaviti na kasi bez upotrebe ručnog terminala.

prikaz na ekranu

Upit o stanju baterije (prazno,puno)

Mogućnost montaže sa donje i zadnje strane

Elektrostatička boja u prahu protiv rđe

Na podu proizvoda itison

4 komada baterije (poklopac na kućište baterija je zašarafljen)

OPREMA ENTERIJERA PROSTORIJA



STM-140



STM-141



STM-142



STM-143

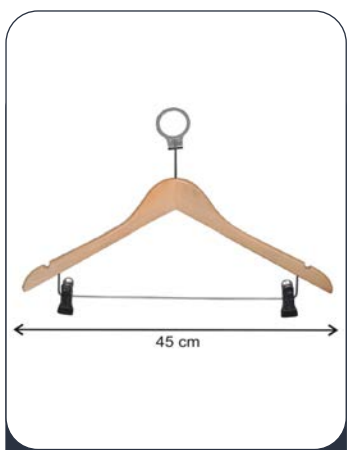

8037 | DRVENA VJEŠALICA

METALNI PRSTEN SA ŠTIPAVICOM

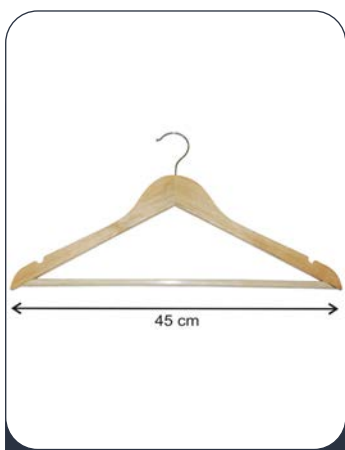

7569 | DRVENA VJEŠALICA

SA KUKOM

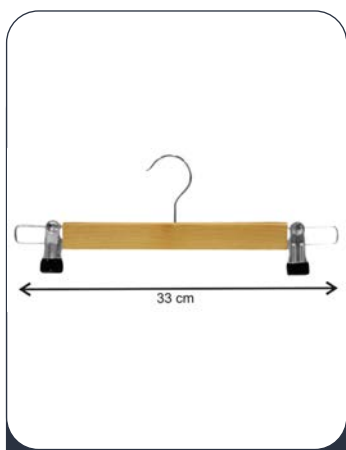

7734

VJEŠALICA ZA SUKNJU

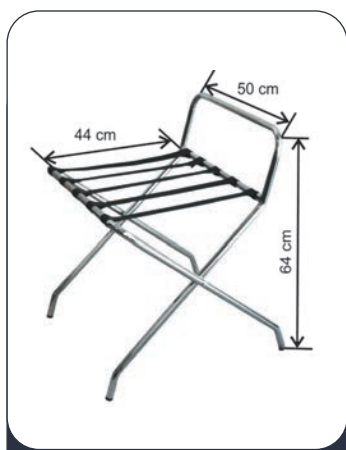

1501 | STO ZA PRTLJAG

OBOJENO



7935

HOTELSKI TIP DASKA ZA PEGLANJE



8036

HOTELSKI TIP PEGLA KERAMIČKO DNO
1500-2000 WATT

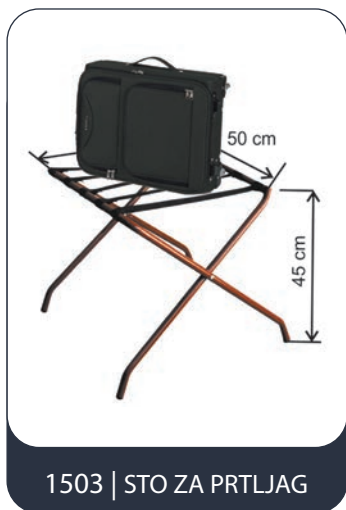

1503 | STO ZA PRTLJAG

OBOJENO



7622

304 KVALITETNI KETELJ
NERĐAJUĆI ČELIK



7005 | DRVO

POSUŽAVNIK ZA SERVIRANJE



7006 | DRVO

POSUŽAVNIK ZA SERVIRANJE
27x45x1,8 cm



7007 | DRVO

POSUŽAVNIK ZA BOUCLE
7x45x1,8 cm



ZIDNA SVETILJKA | ST458

OBOJENO



ZIDNA SVETILJKA | ST460

STARI METAL



ZIDNA SVETILJKA | ST461

HROM



ZIDNA SVETILJKA | ST462

OBOJENO



1001 | 3 LT

KANTA ZA SMEČE SA
PEDALOM PLASTIKA SA
UNUTRAŠNJOM KANTOM



1002 | 5 LT

KANTA ZA SMEČE SA
PEDALOM PLASTIKA SA
UNUTRAŠNJOM KANTOM



1432 | 3 LT

KANTA ZA SMEČE SA
UNUTRAŠNJOM KANTOM SA
KRUGOM PLASTIKA



1433 | 5 LT

KANTA ZA SMEČE SA
UNUTRAŠNJOM KANTOM SA
KRUGOM PLASTIKA



RESTORAN HOTELA TANJIRI



RESTORAN HOTELA ZDJELE





HOTEL BARSKI PRIBOR



RESTORAN HOTELA ČAŠE



RESTORAN HOTELA SETOVI PRIBORA ZA JELO



RESTORAN HOTELA PROZVODI SERVISA



RESTORAN HOTELA BOKAL, KARAF



RESTORAN HOTELA STOLNI TEKSTIL



TEPIH, PARKET I ZIDNI PAPIR

TEPIH, PARKET I ZIDNI PAPIR



HOTELSKI PARKET - ST121



HOTELSKI PARKET - ST123



HOTELSKI PARKET - ST125



HOTELSKI PARKET - ST126



HOTELSKI PARKET - ST128



HOTELSKI PARKET - ST129



HOTELSKI PARKET - ST130



HOTELSKI PARKET - ST132



HOTELSKI PARKET - ST133



HOTELSKI PARKET - ST134



HOTELSKI PARKET - ST135



HOTELSKI PARKET - ST136

TEPIH, PARKET I ZIDNI PAPIR



HOTELSKI PARKET - ST137



HOTELSKI PARKET - ST138



HOTELSKI PARKET - ST139



HOTELSKI PARKET - ST142



HOTELSKI PARKET - ST144



HOTELSKI PARKET - ST145



HOTELSKI PARKET - ST146



HOTELSKI PARKET - ST147



HOTELSKI PARKET - ST148



HOTELSKI PARKET - ST151



HOTELSKI PARKET - ST152



HOTELSKI PARKET - ST154



TEPISI OD ZIDA DO ZIDA - ST586



TEPISI OD ZIDA DO ZIDA - ST583



TEPISI OD ZIDA DO ZIDA - ST581

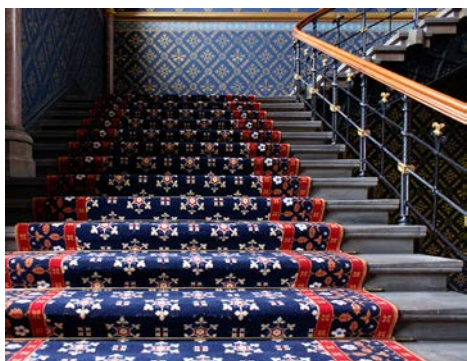

TEPISI OD ZIDA DO ZIDA - ST580



TEPISI OD ZIDA DO ZIDA - ST591



TEPISI OD ZIDA DO ZIDA - ST592



TEPISI OD ZIDA DO ZIDA - ST562



TEPISI OD ZIDA DO ZIDA - ST564

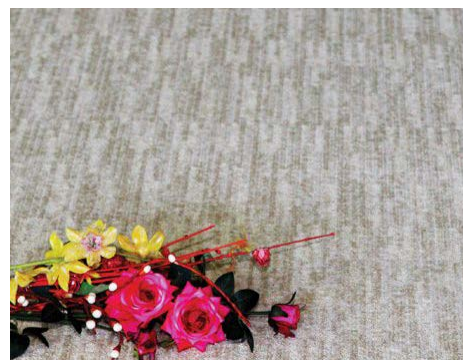

TEPISI OD ZIDA DO ZIDA - ST832

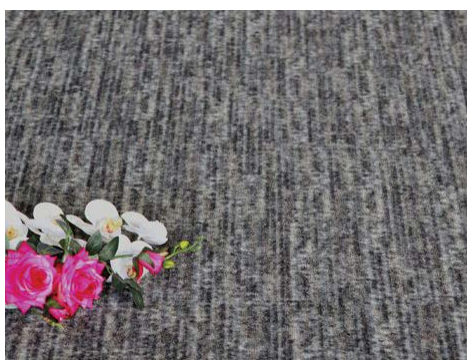

TEPISI OD ZIDA DO ZIDA - ST833

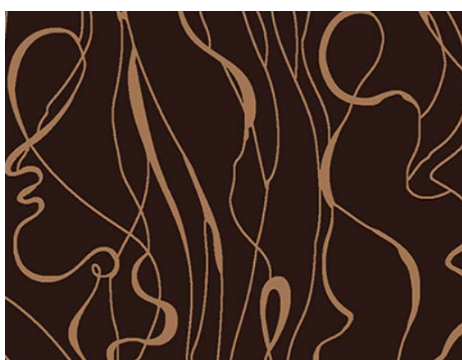

TEPISI OD ZIDA DO ZIDA - ST576

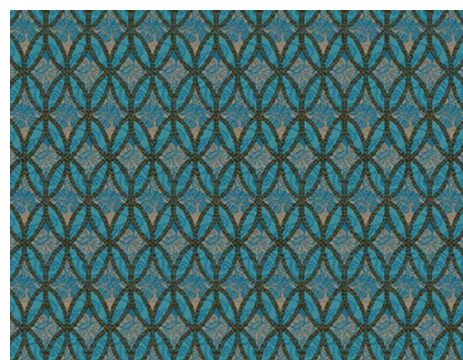

TEPISI OD ZIDA DO ZIDA - ST571



TEPISI OD ZIDA DO ZIDA - ST425



TEPISI OD ZIDA DO ZIDA - ST432

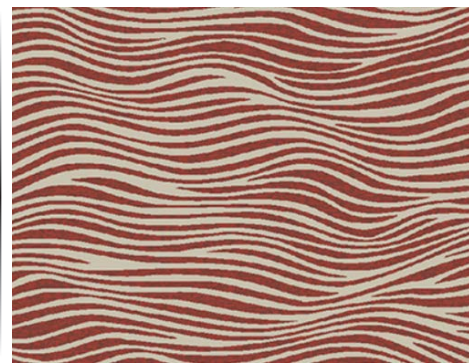

TEPISI OD ZIDA DO ZIDA - ST456



TEPISI OD ZIDA DO ZIDA - ST478



TEPISI OD ZIDA DO ZIDA - ST413

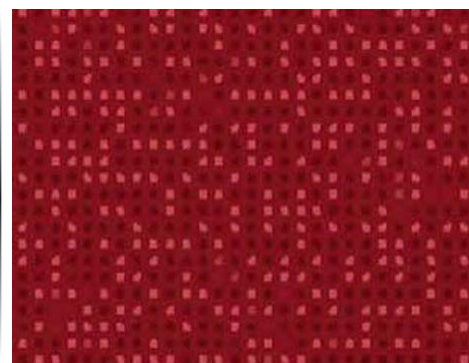

TEPISI OD ZIDA DO ZIDA - ST468

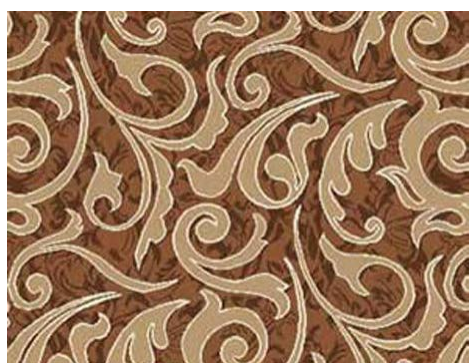

TEPISI OD ZIDA DO ZIDA - ST481

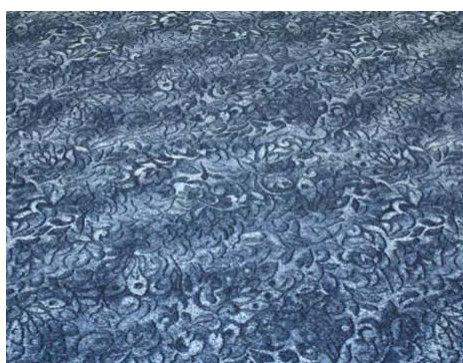

TEPISI OD ZIDA DO ZIDA - ST316



TEPISI OD ZIDA DO ZIDA - ST317



TEPISI OD ZIDA DO ZIDA - ST319



TEPISI OD ZIDA DO ZIDA - ST286

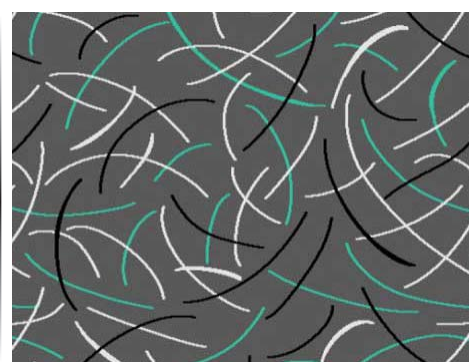

TEPISI OD ZIDA DO ZIDA - ST289



TAPETE HOTELSKOG TIPA - ST313



TAPETE HOTELSKOG TIPA - ST314



TAPETE HOTELSKOG TIPA - ST315



TAPETE HOTELSKOG TIPA - ST323



TAPETE HOTELSKOG TIPA - ST324



TAPETE HOTELSKOG TIPA - ST325

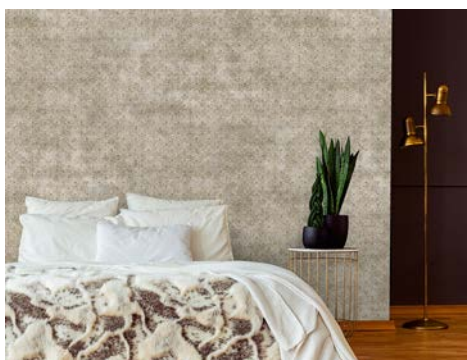

TAPETE HOTELSKOG TIPA - ST333



TAPETE HOTELSKOG TIPA - ST334



TAPETE HOTELSKOG TIPA - ST335



TAPETE HOTELSKOG TIPA - ST342



TAPETE HOTELSKOG TIPA - ST343



TAPETE HOTELSKOG TIPA - ST344



TAPETE HOTELSKOG TIPA - ST351



TAPETE HOTELSKOG TIPA - ST352



TAPETE HOTELSKOG TIPA - ST353



TAPETE HOTELSKOG TIPA - ST365



TAPETE HOTELSKOG TIPA - ST366



TAPETE HOTELSKOG TIPA - ST367



TAPETE HOTELSKOG TIPA - ST371



TAPETE HOTELSKOG TIPA - ST372



TAPETE HOTELSKOG TIPA - ST373



TAPETE HOTELSKOG TIPA - ST384

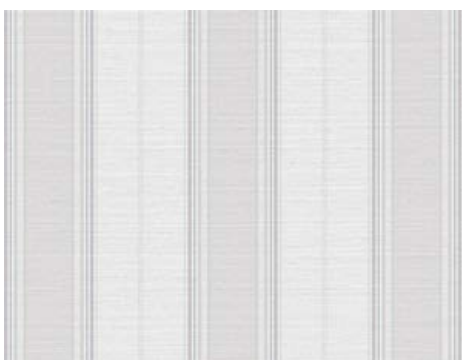

TAPETE HOTELSKOG TIPA - ST385



TAPETE HOTELSKOG TIPA - ST386

FEN ZA KOSU 1200 WATT



Tehničke karakteristike

- 2 Boje Crna/Bijela
- 1200W Snaga
- 2-Stepeno Podešavanje Brzine
- 2-Stepeno Podešavanje Topline
- Jednostavna Montaža na zid
- Šrafovi za Pričvršćivanje i tiplovi
- 87 m³/h Protok Vazduha
- 685 gr Težina Proizvoda
- Opiona Karakteristika
- 110 / 220 V Utičnica Za Mašinu Za Brijanje

FEN ZA KOSU 1600 WATT



Teknik Özellikler

- 2 Boje Crna/Bijela
- 1600W Crna, 1600W Bijela
- 1600W 110V SA Crnom utičnicom,
- 1600W 110V Sa Bijelom utičnicom
- 1600W Snaga
- Moderan dizajn sa hromiranim dijelovima
- 2-Stepeno Podešavanje Brzine
- 2-Stepeno Podešavanje Topline
- Jednostavna montaža na zid
- Sakupljač Vazduha
- Šrafovi za pričvršćivanje i tiplovi
- 87 m³/h Protok Vazduha
- 1188 gr Težina Proizvoda (Uključujući Priključak)
- Opiona Karakteristika
- 110 / 220 V Utičnica Za Mašinu Za Brijanje

OPREMA ZA KUPATILO



7309

SUŠAČ ZA RUKE SA BRZIM MOTOROM
KARAKTERISTIKE MAŠINE
DIMENZIJE: 39X58X27 Cm

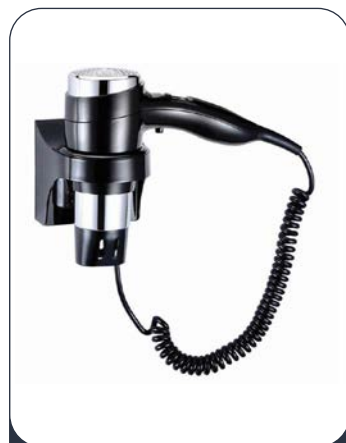

7009 | TIP HOTELA

FEN ZA KOSU
SNAGA OTPORA: 1600W
PREKIDAČ, SIGURNOST
PREKIDAČ, SPIRALNI KABL



7008 | TIP HOTELA

FEN ZA KOSU
SNAGA OTPORA: 1600W
PREKIDAČ, SIGURNOST
PREKIDAČ, SPIRALNI KABL



7164 | TIP HOTELA

FEN ZA KOSU
ETAP OTELLO
MONTIRAN NA ZID SA OKIDAČEM
SA JEDNIM CIKLUSOM – SNAGA: 1350W



7506 | AÇELYA

JEDNO OGLEDALO 50X60



7635 | MESING

LUKSUZNA POSUDA ZA
ČETKICU ZA ZUBE



7636 | MESING

LUKSUZNA POSUDA ZA SAPUN

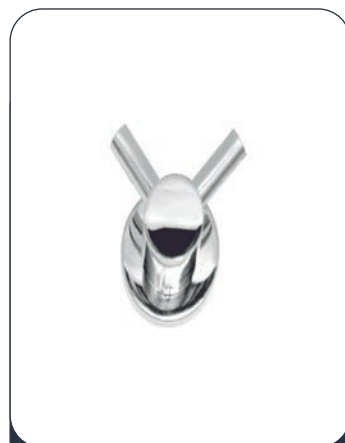

7642 | MESING

LUKSUZNA VJEŠALICA ZA
BADE MANTIL



7643 | MESING

DUGI LUKSUZNI DRŽAČ PEŠKIRA



7639 | MESING

LUKSUZNA POSUDA PAPIRA



7638 | MESING

LUKSUZNA POSUDA PAPIRA ZA
WC SA POKLOPCEM



7637 | MESING

LUKSUZNA REZERVNA
POSUDA PAPIRA ZA WC

OPREMA ZA KUPATILO



7800 | HROM

ABS POSUDA ZA TEČNI SAPUN
GEL ZA TUŠIRANJE, ŠAMPON
LOSION ZA PRANJE 380 ML



7801 | SIVA

ABS POSUDA ZA TEČNI SAPUN
GEL ZA TUŠIRANJE, ŠAMPON
LOSION ZA PRANJE 380 ML



7802 | BIJELA

ABS POSUDA ZA TEČNI SAPUN
GEL ZA TUŠIRANJE, ŠAMPON
LOSION ZA PRANJE 380 ML



7803 | HROM

ABS POSUDA ZA TEČNI SAPUN
DVA KOMADA 380 ML
GEL ZA TUŠIRANJE, ŠAMPON
LOSION ZA PRANJE



2210 | HROM

ABS POSUDA ZA TEČNI SAPUN
GEL ZA TUŠIRANJE, ŠAMPON
LOSION ZA PRANJE 500 ML



2211 | HROM

ABS POSUDA ZA TEČNI SAPUN
GEL ZA TUŠIRANJE, ŠAMPON
LOSION ZA PRANJE 500 ML



2212 | HROM

ABS POSUDA ZA TEČNI SAPUN
GEL ZA TUŠIRANJE, ŠAMPON
LOSION ZA PRANJE 1000 ML



2213 | HROM

ABS POSUDA ZA TEČNI SAPUN
GEL ZA TUŠIRANJE, ŠAMPON
LOSION ZA PRANJE 1000 ML



7261

DRŽAČ PAPIRA SA FOTOČELIJOM
FIKSNA BRAVA
DIMENZIJA PAPIRA: 21 cm
ABS SA KUČIŠTEM OD TVRDE PLASTIKE
DIMENZIJE: 20x25x30
SA ADAPTEROM



7934

DRŽAČ PAPIRA SA FOTOČELIJOM
FIKSNA BRAVA
DIMENZIJA PAPIRA: 21 cm
ABS SA KUČIŠTEM OD TVRDE PLASTIKE
DIMENZIJE: 20x25x30
SA ADAPTEROM

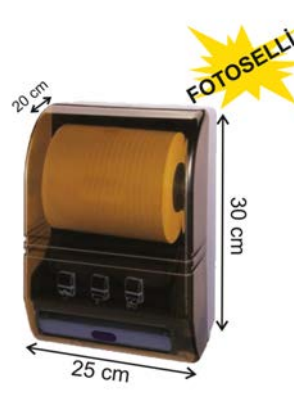

7574

DRŽAČ PAPIRA SA FOTOČELIJOM
FIKSNA BRAVA
DIMENZIJA PAPIRA: 21 cm
ABS SA KUČIŠTEM OD TVRDE PLASTIKE
DIMENZIJE: 20x25x30
SA ADAPTEROM



7514

SUŠAČ ZA RUKU
220V-240V-/50HZ
SNAGA:1400W- TEŽINA:8,5 KG
DIMENZIJE: 680X300X250 mm

OPREMA ZA KUPATILO



7687 | MESING

DUGI LUKSUZNI DRŽAČ PEŠKIRA
50CM



7688 | MESING

LUKSUZNI DRŽAČ PEŠKIRA
30 CM



7679 | MESING

LUKSUZNA VJEŠALICA ZA BADE
MANTIL DVA KOMADA



7680 | MESING

LUKSUZNA VJEŠALICA ZA BADE
MANTIL DVA KOMADA



7320

VJEŠALICA OD MESINGA ZA
BADE MANTIL



7322

DUGI DRŽAČ PEŠKIRA OD
MESINGA



7323

VJEŠALICA OD MESINGA ZA
BADE MANTIL SIDRO



8002 | 304 KALITE

POSUDA PAPIRA ZA WC



7074 | JEDAN UGAO

DRŽAČ SUNDJERA OD
MESINGA18X18



7077 | DVOSTRUKI UGAO

DRŽAČ SUNDJERA OD
MESINGA18X18



7080 | TROSTRUKI UGAO

DRŽAČ SUNDJERA OD
MESINGA18X18



8001 | 304 KVALITET

POSUDA PAPIRA ZA WC
SA POKLOPCEM

OPREMA ZA KUPATILO

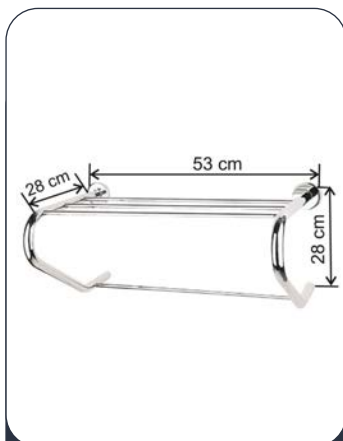

8032 | POLICA ZA PEŠKIRE

304 KVALITET- SA PODRŠKOM

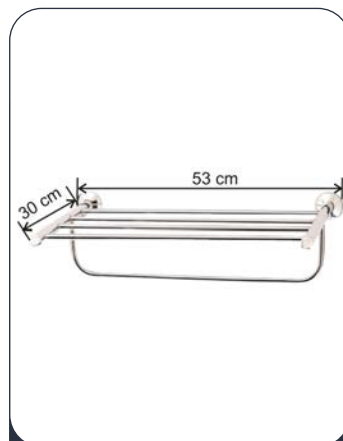

8033 | POLICA ZA PEŠKIRE

304 KVALITET



8034 | POLICA ZA PEŠKIRE

304 KVALITET- SA PODRŠKOM



7148 | RAVNO

RUČKA ZA INVALIDE
50 cm DUŽINA 304 KVALITET
NERĐAJUĆI ČELIK MAT 32x1,20 mm



7291 | DRVO

SJEDIŠTE ZA INVALIDE
SA TABLOM POMERAJUĆI
304 KVALITET NERĐAJUĆI ČELIK MAT



7065 | ČETKA ZA WC

HROM



2205 | AUTOMATIK

HROM ČETKA ZA WC



7458 | ČETKA ZA WC

HROM 304 KVALITET



7697 | MESING

MONTIRANA ČETKA ZA WC



7698 | MESING

MONTIRANA STAKLENA ČETKA WC



7253 | SJAJNO
7255 | MAT

304 KVALITET HROM POSUDA
TEČNOG SAPUNA
1 LT. MONTIRAN NA ZID
DIMENZIJE: 12,1X20,6X7,2 cm



7286 | SJAJNO
7461 | MAT

304 KVALITETNI SJAJNI TEČNI SAPUN
500 ML MONTIRAN NA ZID
DIMENZIJE: 15x9x5 cm

OPREMA ZA KUPATILO



7652-S

ČETKA ZA WC



7463 | DUPLO

KAPACITET 0.250 LT.



7464 | TROSTRUKO

KAPACITET 0.250 LT.



7469 | DUPLO

KAPACITET 0.170 LT.



7655-S

POSUDA TEČNOG SAPUNA



7654-S

POSUDA ZA SAPUN PJENU



1012 - 70LT

KANTA ZA SMEĆE SA PEDALOM



1070 - 95LT

KANTA ZA SMEĆE SA PEDALOM



1096 - 35LT

POCINČANA SA PEDALOM
KANTA ZA SMEĆE
SA UNUTRAŠNJOM KANTOM



1097 - 45LT

POCINČANA SA PEDALOM
KANTA ZA SMEĆE
SA UNUTRAŠNJOM KANTOM



1098 - 35LT

KANTA ZA SMEĆE SA PEDALOM
CRNI MAT POCINČANI
SA UNUTRAŠNJOM KANTOM
VODOOTPORAN

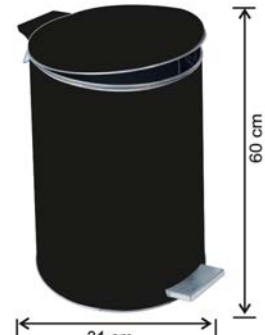

1099 - 45LT

KANTA ZA SMEĆE SA PEDALOM
CRNI MAT POCINČANI
SA UNUTRAŠNJOM KANTOM
VODOOTPORAN

HOTELSKI SPRAT I SREDSTVA ZA ČIŠĆENJE



7359 | KOLICA ZA SPRAT

OBOJENA PRESANA KOLICA ZA SPRAT



7350 | OBOJENO

KOLICA ZA ČIŠĆENJE
90X45X80



7351 | HROM

KOLICA ZA ČIŠĆENJE
90X45X87

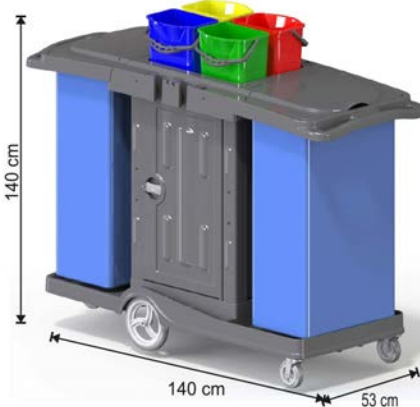

7358 | KOLICA ZA SPRAT

KOLICA ZA SPRAT SA ORMAROM



7353

OBOJENI METAL PRESAN
KOLICA ZA ČIŠĆENJE 90X45X80



7355

METALNA PRESA



7356

RINDO METALNA PRESA



7354

MIMOZA PLASTIČNA PRESA

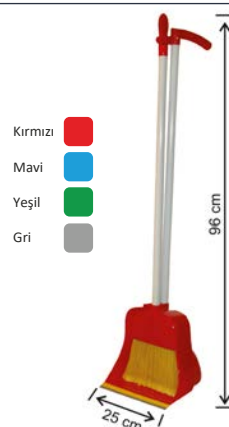

7580

LUKSUZNA LOPATA ZA
SMEĆE SA METLROM



7357

ZNAK KLIZAV POD

HOTELSKI SPRAT I SREDSTVA ZA ČIŠĆENJE



7731

KOLICA ZA SPRAT JUMBO HROM



7584

KOLICA ZA SAKUPLJANJE VEŠA DVOSTRUKO OBOJENO



7585

KOLICA ZA SAKUPLJANJE VEŠA DVOSTRUKO HROM



7489

KOLICA ZA VEŠ SERVIS



7496

KOLICA ZA VEŠ SERVIS



7490

KOLICA ZA SAKUPLJANJE VEŠA



7500 | HROM

TERETNA KOLICA



7501 | OBOJENO

TERETNA KOLICA



7361

MILLENIUM VEŠ OBOJENA KOLICA ZA SAKUPLJANJE



7556 | 80 LT

PLASTIČNI KONTEJNER

HOTELSKI SPRAT I SREDSTVA ZA ČIŠĆENJE

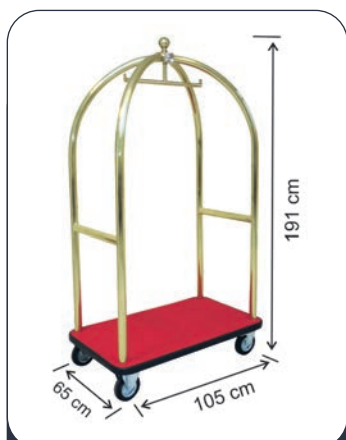

7453 | MESING

KOLICA ZA NOŠENJE PRTLJAGA

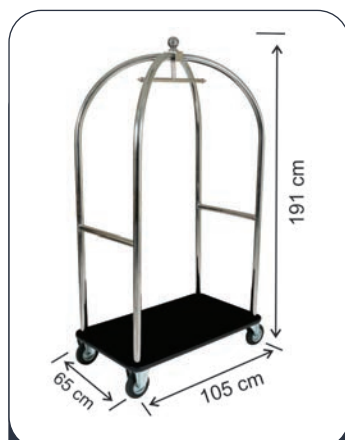

7454 | HROM

KOLICA ZA NOŠENJE PRTLJAGA

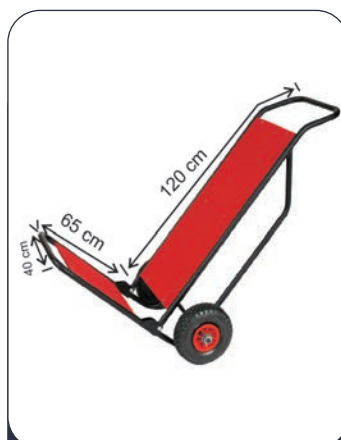

7455 | OBOJENO

KOLICA ZA NOŠENJE PRTLJAGA

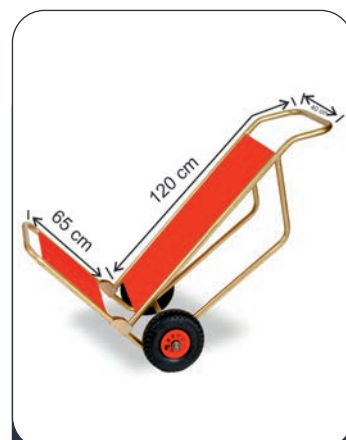

7455-P | MESING

KOLICA ZA NOŠENJE PRTLJAGA

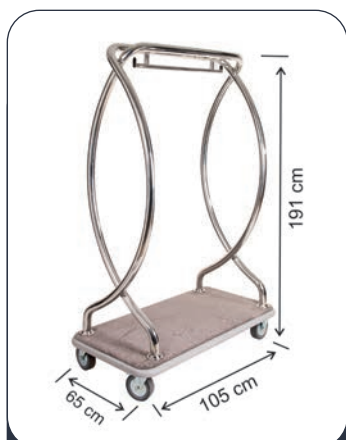

7502 | HROM

KOLICA ZA NOŠENJE PRTLJAGA



7512 | HROM

KOLICA ZA NOŠENJE PRTLJAGA



7523 | NERĐAJUĆI

430 KVALITET

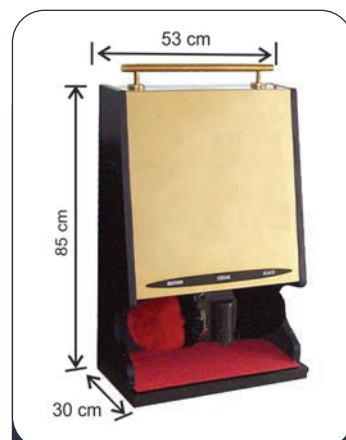

7521

MAŠINA ZA POLIRANJE OBUĆE

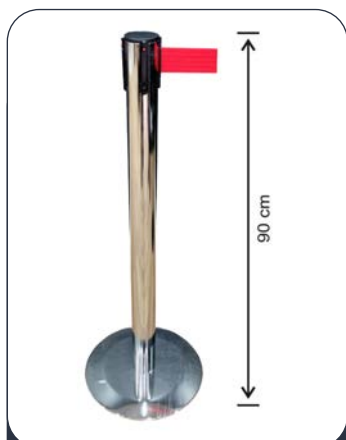

7520

NERĐAJUĆI BARIJER

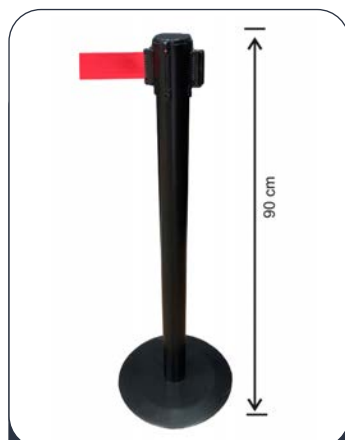

7570

OFARBANA BARIJERA



9107

BRIJERA STUB TRAKA 2,5 m



7601

KABL 2 m



BOUCLE PROIZVODI



HOTEL BOUCLE SAPUNI



HOTEL BOUCLE FLAŠE

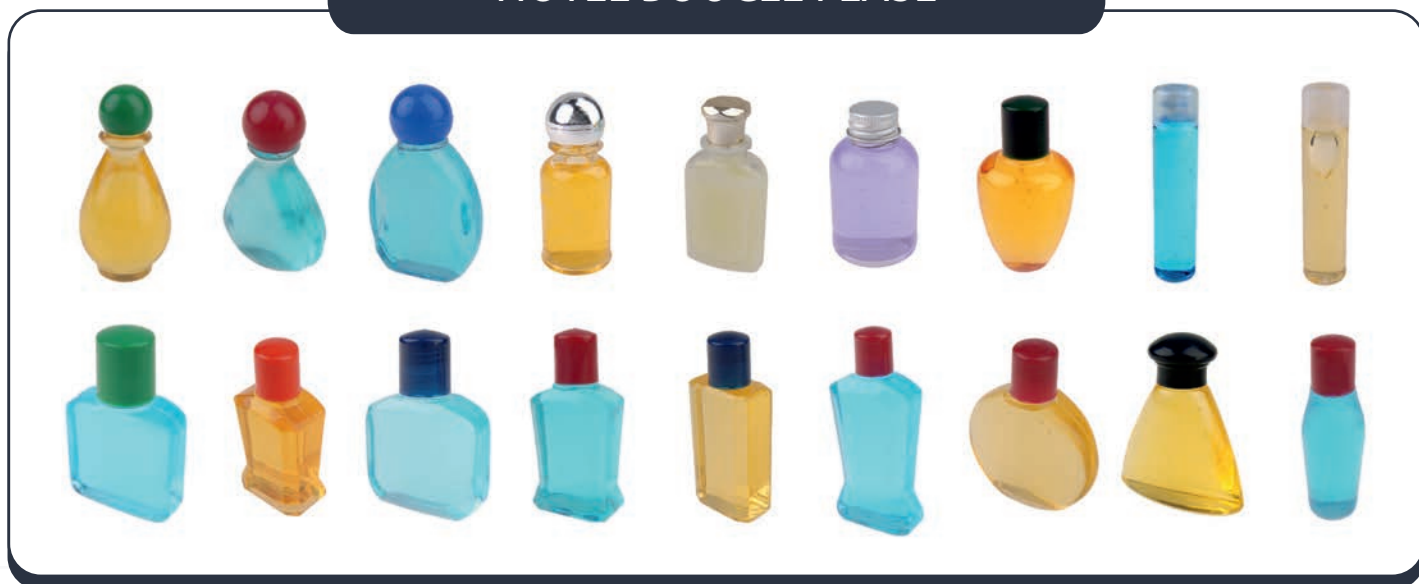

HOTEL BOUCLE PAPUČE



HOTELSKE BOUCLE KUTIJE



KUTIJA ZA LAKIRANJE OBUĆE



KUTIJA ZA TUFER



KUTIJA ZA TURPIJU



KUTIJA ZA UGRADNJU SET ZA ŠIVANJE



KUTIJA ZA ŠTAPIĆE ZA UŠI



KUTIJA ZA ŠTAPIĆE ZA UŠI SA POKLOPCEM



KUTIJA ZA TUŠ KAPU



KUTIJA ZA ČEŠALJ



KUTIJA ZA PJENU ZA BRIJANJE



KUTIJA ZA SET BRIJANJE



KUTIJA ZA TURPIJE



KUTIJA ZA ŠIVANJE

HOTEL BOUCLE OSTALI PROIZVODI



HOTEL BOUCLE OSTALI PROIZVODI

